



1 DESCRIPTION

The Hono CobraNet 8.0M is a CobraNet interface designed for use in the professional installed sound market. This device inputs eight channels of mic/line level balanced audio and transmits them up to 16 channels of CobraNet. Powerful floating point DSP processing provides each microphone pre-amp with a 5-band parametric equalizer and compressor/limiter.

The Hono CobraNet 8.0M has been purposely designed to compliment and fully integrate with all of today's CobraNet compatible DSP products. In addition, this is the ideal solution for many situations where a project requires numerous channels of digital audio routed throughout a facility, but doesn't require a dedicated DSP processor.

2 FEATURES

Inputs

- Eight balanced analog microphone/line
- Software adjustable, non-volatile, input levels from -60 to +26dBu
- 105dB DNR, -98dB THD+N, -120dBu EIN
- Software selectable 48V phantom power individually available on all inputs
- Pluggable terminal block connectors (Phoenix style)

CobraNet

- Redundant CobraNet
- Sixteen channels of CobraNet in and out
- Four CobraNet transmitters and eight receivers

DSP

- Peak and RMS meters on all audio inputs
- 5 band parametric equalizer on each input
- Compressor/Limiter on each input

Power

- Built-in 90-260VAC power supply

Chassis

- 1U rack-mount unit
- 1 RU, 19"(482mm) W x 8"(203mm) L x 1.75"(44mm) H

Control

- All settings adjustable from ASIControl software

3 ARCHITECTS AND ENGINEERS SPECIFICATION

The CobraNet interface shall provide eight microphone/line balanced analog audio inputs on plug in terminal block connectors. 48V DC Phantom power shall be provided on each mic/line input. Analog-to-digital conversion shall be 24bit at a 48kHz sample rate. The CobraNet interface shall provide front panel meters to monitor the analog inputs. Sixteen channels of redundant CobraNet input and output shall be provided on an RJ-45 connector. The CobraNet interface shall be compatible with the AudioScience ASIControl software for configuration and monitoring. The CobraNet interface shall be powered by a built-in 90-240VAC power supply. The CobraNet interface shall be compliant with CE, FCC part 48 and the RoHS directive. Warranty shall be 3 years. The CobraNet interface shall be the AudioScience Hono CobraNet 8.0M.

4 SPECIFICATIONS

COBRANET INPUT/OUTPUT

Type	100BaseT Ethernet
Connector	RJ-45
Precision	16, 20 or 24bit PCM
Sample Rate	48kHz
Latency	1.33, 2.67 or 5.33ms
Control Protocol	SNMP

MICROPHONE/LINE INPUT

Type	Balanced
Connector	3.81mm Terminal block
Input Level	-60 to +26dBu in 1dB increments
Input Impedance	10K Ohms
Phantom Power	48V @ 5mA max per input, software selectable on each input; on and off
Dynamic Range ^[1]	>105dB
THD+N ^[2]	< -98dB
EIN ^[3]	-120dBu
A/D converter	24bit Over sampling
Sample Rate	48 kHz
Frequency Response	20Hz to 20kHz +/-0.25dB

LATENCY (48 kHz CobraNet (CN))	5.33ms CN latency	2.67ms CN latency	1.33ms CN latency
Analog input to CobraNet output	6.97ms	4.29ms	2.95ms

REGULATORY

FCC Part 48 Class A (US)
 CE Mark (EN55022 Class A EN55024)
 RoHS Compliant

GENERAL

Dimensions	1 U, 19"(482mm) W x 8"(203mm) L x 1.75"(44mm) H
Weight	7 lb (3.2kg) max
Operating Temperature	0C to 60C
Power Requirements	100-240VAC, 47-63Hz, 25W max.

[1] – Dynamic range measured with a –60dBFS sine wave and A weighting filter and 20-20kHz b/w
 [2] - THD+N measured using a +20dBu 1kHz sine wave sampled at 48kHz, 20-20kHz b/w and A weighting filter
 [3] - With Zs = 150ohms and Input level set to –10dBu

5 BLOCK DIAGRAM

Hono CobraNet 8.0M

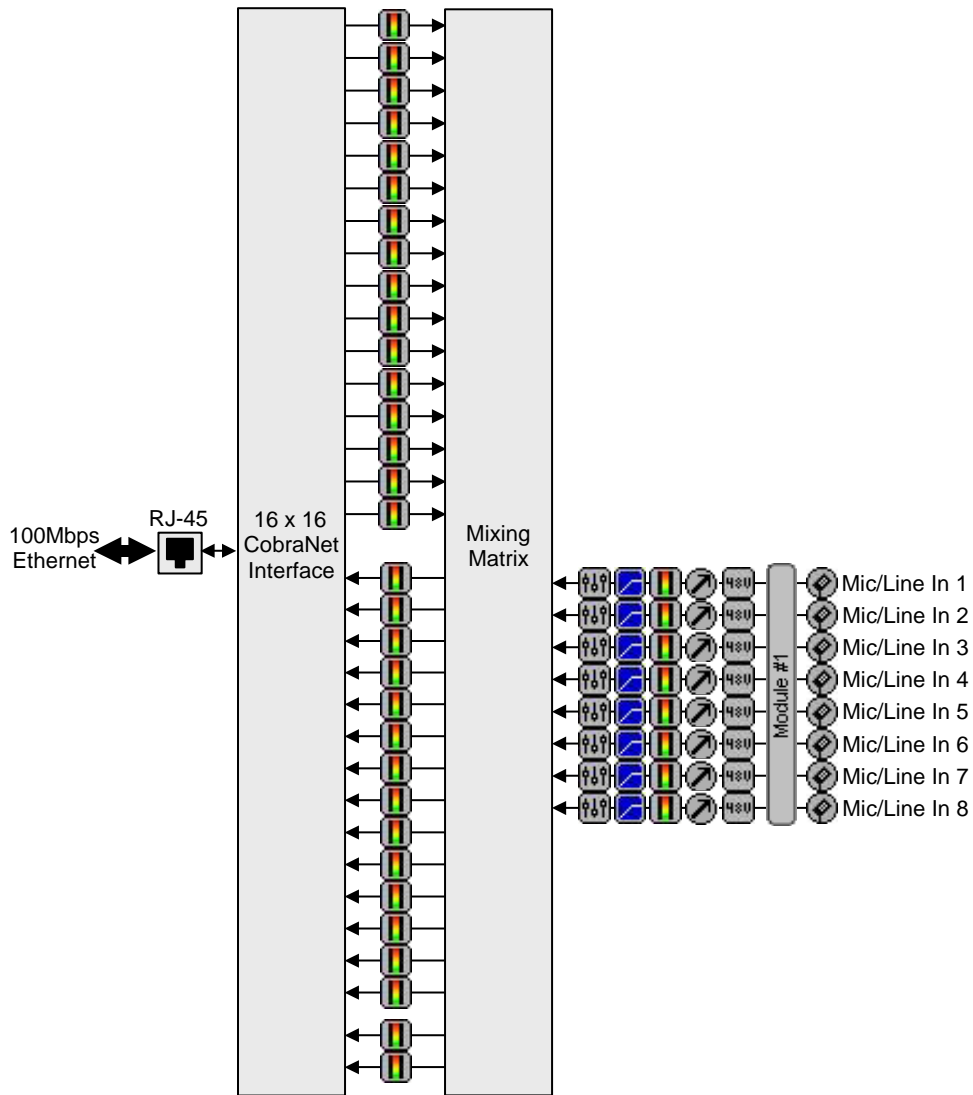

Key:

-  Meter
-  Level
-  Equalizer
-  Phantom Power
-  Compressor
-  Mic Input

6 REVISIONS

Date	Description
22 August 2011	Preliminary.

7 CONTENTS

1	DESCRIPTION	1
2	FEATURES	1
3	ARCHITECTS AND ENGINEERS SPECIFICATION	2
4	SPECIFICATIONS	2
5	BLOCK DIAGRAM	3
6	REVISIONS	4
7	CONTENTS	5
8	TABLE OF FIGURES	7
9	IMPORTANT SAFETY INSTRUCTIONS	8
10	NOTICES	10
11	INTRODUCTION	11
11.1	COBRANET™	12
11.2	COBRANET ROUTING	12
11.2.1	Audio Routing Channels	13
11.2.2	CobraNet Transmitters	14
11.2.3	CobraNet Receivers	14
11.2.4	CobraNet Sample Rate and Latency	14
11.2.5	CobraNet References	14
12	HARDWARE INSTALLATION	15
12.1	RACK MOUNTING	15
12.2	ETHERNET CONNECTION	15
12.3	AC POWER	15
13	OPERATION	16
13.1	POWER UP SEQUENCE	16
13.1.1	AC Power.....	16
13.1.2	Firmware images	16
13.1.3	Firmware loading sequence.....	16
13.1.4	Loading the factory firmware image.....	16
13.2	FRONT PANEL DISPLAY	17
13.2.1	CobraNet Transmit and Receive Peak Meters Display.....	17
13.2.2	CobraNet Bundle Number and Channel Settings Display	18
13.2.3	MAC and IP Address Display	18
13.2.4	Product Information Display	18
13.2.5	Module Input/Output Meters – Analog Display.....	19
13.2.6	Input/Output Meters – AES/EBU interface	19
13.3	RESETTING THE CONFIGURATION TO DEFAULT SETTINGS	20
13.3.1	Resetting Audio Control Settings	20
13.3.2	Resetting Static IP Address	20
13.3.3	Resetting CobraNet Persistence.....	20
13.4	NETWORK INTERFACE	21
13.4.1	Network Mask Assignment.....	21

14	CONFIGURATION	22
14.1	ASICONTROL CONFIGURATION	22
14.1.1	<i>ASIControl Layout</i>	<i>22</i>
14.1.2	<i>Adapter Information.....</i>	<i>23</i>
14.1.3	<i>Level.....</i>	<i>23</i>
14.1.4	<i>Meter.....</i>	<i>24</i>
14.1.5	<i>Setting AES/EBU Clocking</i>	<i>25</i>
14.1.6	<i>Input and Output Volume Adjustment.....</i>	<i>29</i>
14.1.7	<i>ClockSourceIn.....</i>	<i>29</i>
14.2	COBRANET CONFIGURATION.....	30
14.2.1	<i>Setting Up AudioScience Software to Configure CobraNet.....</i>	<i>30</i>
14.2.2	<i>Configuring CobraNet Using ASIControl.....</i>	<i>32</i>
14.2.3	<i>References.....</i>	<i>36</i>
14.3	NETWORK CONFIGURATION	36
14.3.1	<i>Change IP Address</i>	<i>36</i>
14.3.2	<i>Configure Network Interface and Auto-IP Assignment Range.....</i>	<i>37</i>

8 TABLE OF FIGURES

Figure 1. Hono CobraNet interface block diagram	11
Figure 2. Illustration of a CobraNet bundle going between two CobraNet devices.....	12
Figure 3. Audio routing channel details	13
Figure 4. Hono CobraNet interface display of CobraNet peak meters and bar height mapping to dBFS range ...	17
Figure 5. Hono CobraNet interface bundle display for CobraNet receivers 1 and 2.....	18
Figure 6. Hono CobraNet interface MAC and IP address display	18
Figure 7. Hono CobraNet interface product information display	18
Figure 8. Analog module display	19
Figure 9. AES/EBU module display.....	19
Figure 10. ASIControl layout	22
Figure 11. Adapter information seen in right side of ASIControl.....	23
Figure 12. Using ASIControl to select Line_Out 1.....	23
Figure 13. Level displayed by ASIControl for Line_Out 1	23
Figure 14. A stereo peak meter display; RMS is green and peak is yellow	24
Figure 15. Hono CobraNet interface AES/EBU clocking for Module 1.....	25
Figure 16. Hono CobraNet interface AES/EBU clocking for Module 2.....	26
Figure 17. Selecting Line_Out 1 in ASIControl prior to setting Tx clock source	27
Figure 18. ASIControl display of AES/EBU Line_Out 1 node controls.....	27
Figure 19. ASIControl selection of AES/EBU output clock source.....	28
Figure 20. ASIControl node displays with volumes	29
Figure 21. Clock source information for CobraNet devices as seen in ASIControl.....	29
Figure 22. Laptop to Hono CobraNet interface connection.....	31
Figure 23. ASIControl's Configure CobraNet	32
Figure 24. ASIControl network adapter and IP address assignments	37

9 IMPORTANT SAFETY INSTRUCTIONS

1. Read these instructions.
2. Keep these instructions.
3. Read all warnings.
4. Follow all instructions.
5. Do not use this apparatus near water.
6. Clean only with a dry cloth.
7. Do not block any ventilation openings. Install in accordance with the manufacturer's instructions.
8. Do not install near any heat sources such as radiators, heat registers, stoves, or other apparatus (including amplifiers) that produce heat.
9. Do not defeat the safety purpose of the polarized or grounding-type plug. A polarized plug has two blades with one wider than the other. A grounding type plug has two blades and a third grounding prong. The wide blade or the third prong is provided for your safety. If the provided plug does not fit into your outlet, consult an electrician for replacement of the obsolete outlet.
10. Protect the power cord from being walked on or pinched, particularly at plug ends, convenience receptacles, and the point where they exit from the apparatus.
11. Only use attachments/accessories specified by the manufacturer.
12. Use only with the cart, stand, tripod, bracket, or table specified by the manufacturer, or sold with the apparatus. When a cart is used, use caution when moving the cart/apparatus combination to avoid injury from tip-over.
13. Unplug this apparatus during lightning storms or when unused for long periods of time.
14. Refer all servicing to qualified service personnel. Servicing is required when the apparatus has been damaged in any way, such as power-supply cord or plug is damaged, liquid has been spilled or objects have fallen into the apparatus, the apparatus has been exposed to rain or moisture, does not operate normally, or has been dropped.



This symbol is intended to alert the user to the presence of uninsulated dangerous voltage within the product's enclosure that may be of sufficient magnitude to constitute a risk of electric shock to humans.



This symbol is intended to alert the users to the presence of important operating and maintenance (servicing) instructions in the literature accompanying the product.



CAUTION: To reduce the risk of electric shock, do not remove the cover. No user-serviceable parts inside.

WARNING:

1. To prevent fire or electric shock, do not expose this apparatus to rain or moisture.
2. This apparatus shall not be exposed to dripping or splashing and no objects filled with liquids, such as a vase, shall be placed on the apparatus.
3. This is a Class 1 apparatus, and as such must be connected to a mains socket outlet with a protective earthing connection.
4. The mains plug is used as the disconnect device and shall remain readily operable.

10 NOTICES

FEDERAL COMMUNICATIONS COMMISSION (FCC) INFORMATION

NOTE: This equipment has been tested and found to comply with the limits for a Class A digital device, pursuant to Part 15 of the FCC Rules. These limits are designed to provide reasonable protection against harmful interference in a commercial installation. This equipment generates, uses, and can radiate radio frequency energy and, if not installed and used in accordance with the instructions, may cause harmful interference to radio communications. Operation of this equipment in a residential area is likely to cause harmful interference, in which case the user will be required to correct the interference at his or her own expense.

lwIP

lwIP is licensed under the BSD license:
Copyright (c) 2001-2004 Swedish Institute of Computer Science.
All rights reserved.

Redistribution and use in source and binary forms, with or without modification, are permitted provided that the following conditions are met:

1. Redistributions of source code must retain the above copyright notice, this list of conditions and the following disclaimer.
2. Redistributions in binary form must reproduce the above copyright notice, this list of conditions and the following disclaimer in the documentation and/or other materials provided with the distribution.
3. The name of the author may not be used to endorse or promote products derived from this software without specific prior written permission.

THIS SOFTWARE IS PROVIDED BY THE AUTHOR ``AS IS" AND ANY EXPRESS OR IMPLIED WARRANTIES, INCLUDING, BUT NOT LIMITED TO, THE IMPLIED WARRANTIES OF MERCHANTABILITY AND FITNESS FOR A PARTICULAR PURPOSE ARE DISCLAIMED. IN NO EVENT SHALL THE AUTHOR BE LIABLE FOR ANY DIRECT, INDIRECT, INCIDENTAL, SPECIAL, EXEMPLARY, OR CONSEQUENTIAL DAMAGES (INCLUDING, BUT NOT LIMITED TO, PROCUREMENT OF SUBSTITUTE GOODS OR SERVICES; LOSS OF USE, DATA, OR PROFITS; OR BUSINESS INTERRUPTION) HOWEVER CAUSED AND ON ANY THEORY OF LIABILITY, WHETHER IN CONTRACT, STRICT LIABILITY, OR TORT (INCLUDING NEGLIGENCE OR OTHERWISE) ARISING IN ANY WAY OUT OF THE USE OF THIS SOFTWARE, EVEN IF ADVISED OF THE POSSIBILITY OF SUCH DAMAGE.

11 INTRODUCTION

The Hono CobraNet series of products are CobraNet™ audio interfaces in a 1U rack mount format, providing 16 channels of CobraNet receive and transmit.

The units are populated with various input/output combinations, allowing up to 16 channels of analog or AES/EBU I/O. Each input and output is configured with a pluggable terminal block (Phoenix type) connector).

The Hono CobraNet interface features a powerful Texas Instruments 32bit floating point DSP that allows sophisticated switching and mixing. A graphics display on the unit's front panel shows peak meters and CobraNet status.

AudioScience provides application software that may be used to set up the Hono CobraNet interfaces. ASIControl can be used to set all internal features of the unit (such as levels) and to set CobraNet routing connections to be set up between the Hono CobraNet interfaces and any other compliant CobraNet device on the network.

The following table lists the Hono CobraNet Series and a description of each unit.

Model	Network Protocol	Description
Hono CobraNet 8.0M	CobraNet	8 channels of balanced analog mic/line inputs
Hono CobraNet 8.0L	CobraNet	8 channels of balanced analog line level inputs
Hono CobraNet 16.0M	CobraNet	16 channels of balanced analog mic/line inputs
Hono CobraNet 16.0L	CobraNet	16 channels of balanced analog line level inputs
Hono CobraNet 0.8L	CobraNet	8 channels of balanced line level outputs
Hono CobraNet 0.16L	CobraNet	16 channels of balanced line level outputs
Hono CobraNet 8.8M	CobraNet	8 channels of balanced mic/line inputs and line level outputs
Hono CobraNet 8.8L	CobraNet	8 channels of balanced line level inputs and outputs
Hono CobraNet 16.16M	CobraNet	16 channels of balanced mic/line inputs and line level outputs
Hono CobraNet 16.16L	CobraNet	16 channels of balanced line level inputs and outputs
Hono CobraNet 8.8D	CobraNet	8 (4 stereo) channels of AES/UBU inputs and outputs
Hono CobraNet 16.16D	CobraNet	16 (8 stereo) channels of AES/UBU inputs and outputs

Below is a block diagram of the Hono CobraNet interface. Different models will have different configurations of the audio I/O, per the above table.

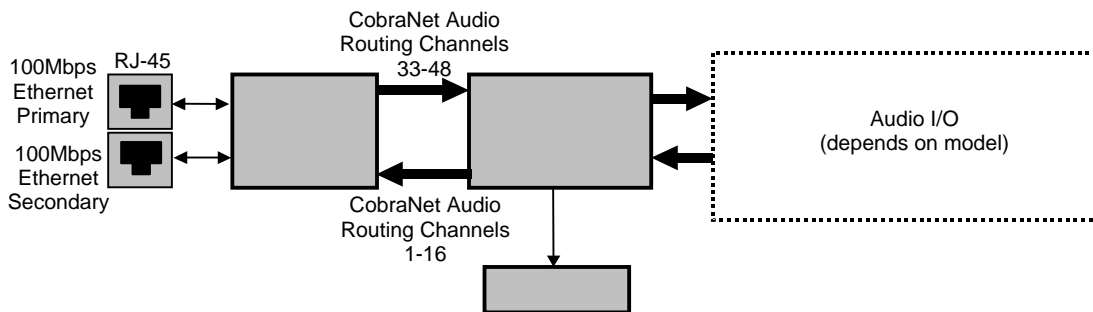

Figure 1. Hono CobraNet interface block diagram

11.1 CobraNet™

CobraNet™ is a combination of software, hardware and network protocol that allows distribution of many channels of real-time, high quality, digital audio over an Ethernet network. It was developed by Peak Audio in the 1990s and is now owned by Cirrus Logic. Interoperability between CobraNet devices from different manufacturers is supported through a standard communications protocol. CobraNet compliant devices are based on a common silicon or hardware reference design from Cirrus Logic.

The Cirrus Logic website, www.cobranet.info, is dedicated to CobraNet.

CobraNet delivers audio in standard Ethernet packets over 100Mbit Fast Ethernet. Switches, hubs, media converters, and other gear that operate in compliance with the IEEE 802.3u specification for Fast Ethernet, will work with CobraNet. CobraNet does not support 10Mbit Ethernet varieties (10BASE-T, Coaxial) due to their limited bandwidth.

CobraNet operates at the Data Link Layer (also referred to as OSI Layer 2 or MAC layer). Because it does not use the higher IP layer for audio data transport, CobraNet does not suffer from IP latency limitations. In most cases data communications and CobraNet data can coexist on the same network without QOS issues. All audio is sent inside a custom Ethernet packet whose header tells network devices that the packet contains CobraNet audio, rather than plain data. The CobraNet term for an audio packet is "bundle". A bundle may contain from one to eight audio channels, each channel being composed of PCM samples of 16, 20 or 24 bits in length.

11.2 CobraNet Routing

The whole point of network audio is to route digital audio from point A to point B. CobraNet introduces a concept called a "bundle" to define virtual audio routes from one CobraNet device to another one. A bundle is a logical collection of up to 8 channels that can be sent from on device to another. Each bundle is assigned a unique number between 1 and 65535. Bundles form the heart of the CobraNet routing capability.

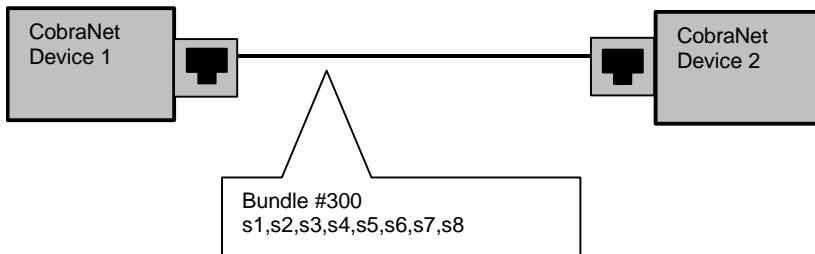

The bundle number 300 is used to describe this collection of channels coming from Device 1. s1 to s8 represent audio samples. The bundle shown above consists of 1 to 8 samples of audio each taken from different channels of Device 1.

Figure 2. Illustration of a CobraNet bundle going between two CobraNet devices

The above figure illustrates a bundle of audio being sent from one CobraNet device to another. Device 1 is transmitting the CobraNet bundle, while Device 2 is receiving it. In this case, both devices need to be set to bundle 300 for the audio link to be made. The CobraNet mechanism for transmitting bundles is "transmitters." Similarly, the mechanism for receiving bundles is "receivers." Each CobraNet device has several transmitters and receivers and so can simultaneously send and receive audio channels using several different bundle numbers. This capability supports audio links between many different CobraNet devices.

11.2.1 Audio Routing Channels

Before further discussion of CobraNet transmitters and receivers, terminology useful for specifying audio channels within a bundle needs to be introduced. Somewhat obviously, these channels are called the Audio Routing Channels. On a Hono CobraNet interface, audio routing channels 1–16 map to input channels 1–16. Similarly, on the output side audio routing channels 33-48 map to output channels 1–16.

Audio Routing Channels

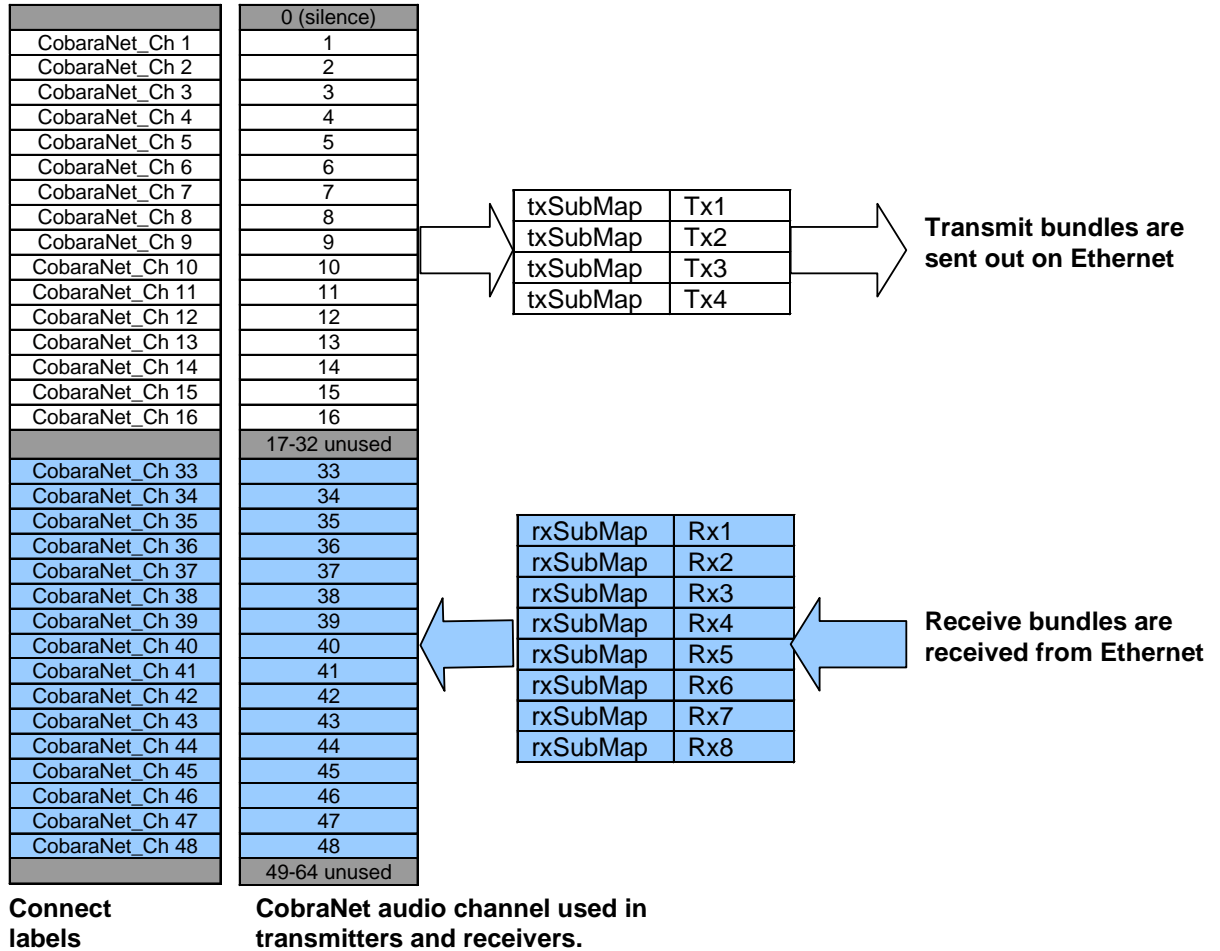

Figure 3. Audio routing channel details.

11.2.2 CobraNet Transmitters

A CobraNet transmitter is a logical entity in the CobraNet interface that has the ability to send a bundle of audio samples on the CobraNet network. CobraNet devices typically have multiple transmitters. Each Hono CobraNet interface, for example, has 4 transmitters. An incomplete list of transmitter routing variables follows:

- txBundle – this variable specifies the bundle number to transmit. A value of 0 indicates that the transmitter is disabled.
- txSubMap – a sequence of up to 8 audio routing channel numbers that specify which audio samples should be placed in the bundle. A value of 0 indicates an unused slot in the bundle.
- txSubFormat – a sequence of format specifiers that define how many bits per sample are placed in the bundle.
- txSubCount – the number of channels in this bundle.

11.2.3 CobraNet Receivers

A CobraNet receiver is a logical entity in the CobraNet interface that has the ability to receive a bundle of audio samples from the CobraNet network. CobraNet devices typically have multiple receivers. Each Hono CobraNet interface, for example, has 4 receivers. An incomplete list of receiver routing variables follows:

- rxBundle – the number of the bundle to receive. This should be the same bundle number being transmitted somewhere else on the network. A value of 0 indicates that the receiver is disabled.
- rxSubMap – a sequence of up to 8 audio routing channel numbers that specify where incoming bundle samples should be routed.

11.2.4 CobraNet Sample Rate and Latency

The CobraNet sample rate supported by s is fixed at 48kHz with three latency modes of 5.33ms (default), 2.67ms, or 1.33ms.

11.2.5 CobraNet References

This document is not intended to be an expansive guide to CobraNet networking and routing. The Hono CobraNet interfaces adhere to the CobraNet standard through the use of off-the-shelf CobraNet silicon from Cirrus Logic. More detailed CobraNet information is available from Cirrus Logic's website.

The following links may be helpful:

CobraNet Info:

<http://www.cobranet.info/en/support/cobranet/>

CobraNet CobraCAD and CobraNet Discovery:

<http://www.cobranet.info/dispatch/forms/sup/boardreg/breg/BregController.jspf>

CobraNet Audio Routing Primer:

http://cirrus.com/en/pubs/appNote/CobraNet_AudioRoutingPrimer.pdf

Hardware Manual and Programmer's Reference:

http://www.cobranet.info/en/support/cobranet/developer/tech_data_sheet.html

Switched Networks and Redundancy:

http://www.cirrus.com/en/support/cobranet/design/switched_networks.html

12 HARDWARE INSTALLATION

12.1 Rack Mounting

The Hono CobraNet interface is 1U (1 rack unit/space) high and mounts in a standard 19-inch equipment rack.

- Use four mounting screws to fasten the front panel of the unit to the 19-inch rack rails.
- Support any cables that are attached to the back of the Hono CobraNet interface so that their weight does not put undue stress on the unit's connectors.
-  Each unit has cooling vents on the side. Be careful not to obstruct these.

12.2 Ethernet Connection



There are two RJ-45 Ethernet jacks on the rear of the unit. If a redundant CobraNet network is not being used then plug a network cable into the PRIMARY jack. If a redundant network is being used then plug a second network cable into the SECONDARY jack. (See http://cobranet.info/support/design/switched_networks for information on redundant networks.)

A CAT-5 or better (CAT-5e, CAT-6 etc) network cable is required for 100baseT Ethernet operation. The cable length between the Hono CobraNet interface and a network switch should not exceed 100 meters (328 feet)

12.3 AC Power



The detachable AC power cord that comes with the Hono CobraNet interface plugs into the IEC connector on the chassis.

The Hono CobraNet interface operates with AC voltages from 90 to 260VAC, 47 to 63Hz. No selection of voltage or frequency is required, as the unit's power supply will automatically adjust.



Use only an AC power source with a protective earth ground.

The Hono CobraNet interface has no power switch. Detach the AC power cord to remove power to the unit.

13 OPERATION

13.1 Power up sequence

This section describes the power up sequence.

13.1.1 AC Power

Connect AC power to the unit by attaching the power cord to the IEC connector on the rear of the unit, as explained in section 12.4

13.1.2 Firmware images

The Hono CobraNet interface boots from a firmware image stored in flash memory. There are two independent firmware images stored in every unit. The two images are named “factory” and “update”. The “factory” image is a reference image that is in place should a “bad” image be downloaded to the device. The “update” image is the image that can be updated in the field if required.

13.1.3 Firmware loading sequence

When first powered up, each Hono CobraNet interface performs the following sequence:

1. Checks for a valid “update” firmware image.
2. Loads the update image and starts running it.
3. Loads any control settings that may have been stored to flash.

In the case where the “update” image is determined to be corrupt, the factory image is loaded.

13.1.4 Loading the factory firmware image

The Hono CobraNet interface can be forced to load the factory firmware image by depressing the SELECT button on front panel as power is applied to the device. Keep button depressed while power is applied.

13.2 Front Panel Display

The display shows information about the Hono CobraNet interface as well as status readings. The select button should be pressed to move to the next display. In order the displays are:

13.2.1 CobraNet Transmit and Receive Peak Meters Display

The first display shows peak meters for all 16 CobraNet receive and transmit routing channels

Peak Meter features:

- Ticks extending from the baseline to the bottom of the display mark every 4th peak meter, i.e. channels 4,8,12, and 16 are marked.
- A "checkered" bar indicates a peak level of -2dBFS or greater.
- Meter bars are 2 pixels wide.
- A missing bar on a receive channel indicates no CobraNet audio connect.
- A 1 pixel high bar indicates CobraNet audio connect, but audio level is below -40 dBFS.
- A 2 pixel high bar indicates CobraNet audio connect and an audio level greater that -40 dBFS but less than -35 dBFS.
- Audio peak levels in the range of -40 dBFS to -20 dBFS are displayed using 5 dB per pixel.
- Audio peak levels in the range of -20 dBFS to 0 dBFS are displayed starting at 6 pixels high and use addition pixels at a rate of 1 pixel very 2 dB.

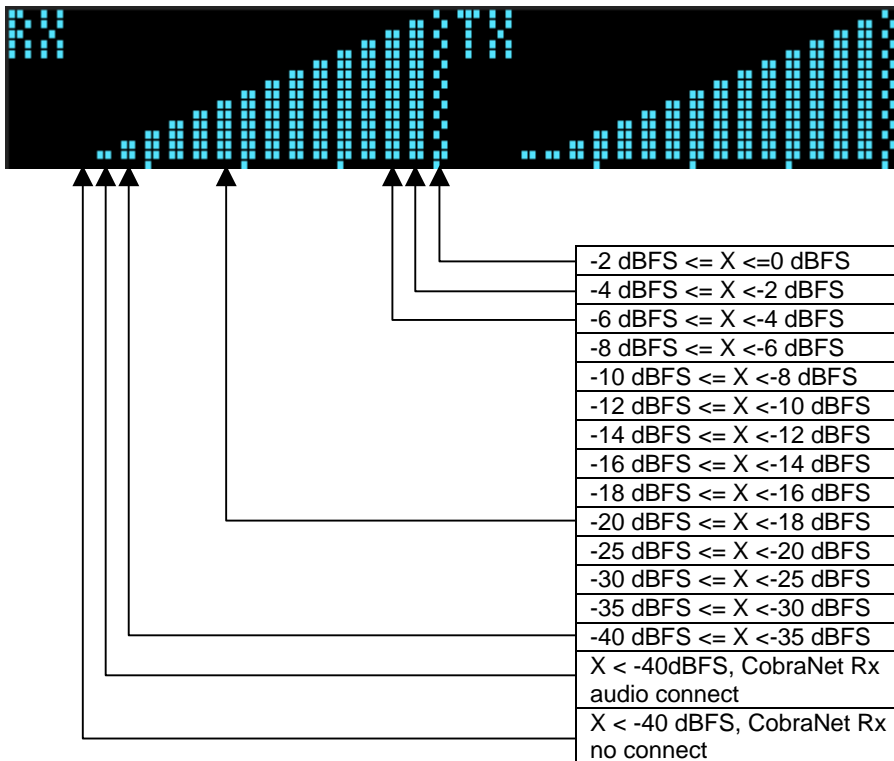

In the above table X is a peak meter reading in dBFS.

Figure 4. Hono CobraNet interface display of CobraNet peak meters and bar height mapping to dBFS range

13.2.2 CobraNet Bundle Number and Channel Settings Display

The bundle panels support displaying bundle and submap information for the device's active CobraNet transmitters and receivers. By default receivers 1 & 2 are displayed and transmitters 1 & 2 are displayed. Additional transmitters and receivers are displayed if they have been assigned a non-zero bundle number indicating that they are active.

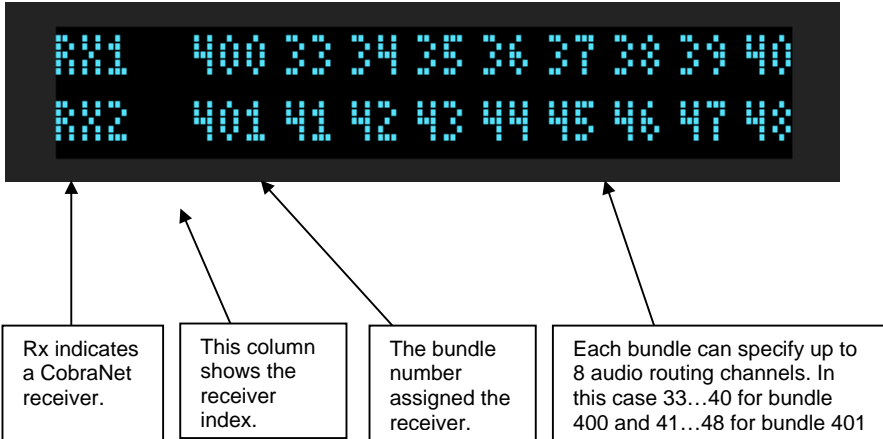

Figure 5. Hono CobraNet interface bundle display for CobraNet receivers 1 and 2

13.2.3 MAC and IP Address Display

This display shows the Hono CobraNet interface's network MAC address and IP address. If the IP address has been assigned dynamically then DYNAM is displayed. If has been assigned statically then STATIC is shown.



Figure 6. Hono CobraNet interface MAC and IP address display

13.2.4 Product Information Display

This display shows:

- Part number (Hono CobraNet 16.16M)
- Revision (R:C3)
- Adapter index (I:1040)
- Serial number (S:12345)
- DSP firmware version (V:4.10.01)
- DSP utilization in % (0%)



Figure 7. Hono CobraNet interface product information display

13.2.5 Module Input/Output Meters – Analog Display

This display shows information and peak meters for an analog module's 8 input and outputs. The meters have the same scale as the CobraNet Transmit and Receive peak meters. From top to bottom, left to right:

- Number and type of installed module (1:Analog)
- Module hardware version (B)
- Input peak meters
- Output peak meters



Figure 8. Analog module display

Peak Meter Features:

- A "checkered" bar indicates a peak level of -2dBFS or greater
- Meter bars are 3 pixels wide
- A missing bar on a receive channel indicates no CobraNet audio connect
- A 1 pixel high bar indicates the audio level is below -40 dBFS
- A 2 pixel high bar indicates an audio level greater than -40 dBFS but less than -35 dBFS
- Audio peak levels in the range of -40 dBFS to -20 dBFS are displayed using 5 dB per pixel
- Audio peak levels in the range of -20 dBFS to 0 dBFS are displayed starting at 6 pixels high and use addition pixels at a rate of 1 pixel very 2 dB

13.2.6 Input/Output Meters – AES/EBU interface

This display shows information and peak meters for an AES/EBU digital interface's 8 input and outputs. The meters have the same scale as the CobraNet Transmit and Receive peak meters.

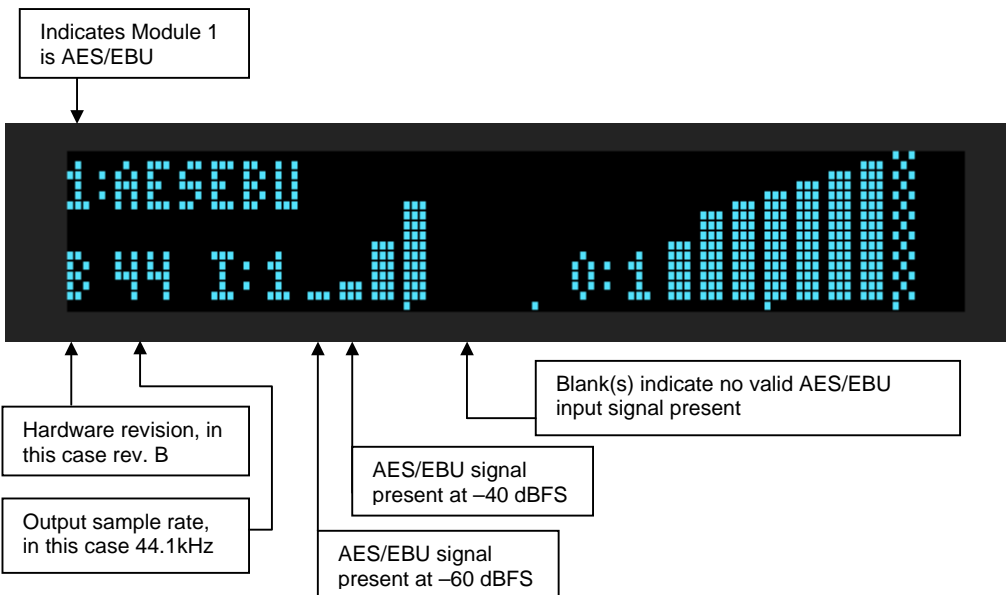

Figure 9. AES/EBU module display

Peak Meter Features:

- A "checkered" bar indicates a peak level of -2dBFS or greater.
- Meter bars are 3 pixels wide.
- A missing bar on a receive channel indicates no CobraNet audio connected.
- A 1 pixel high bar indicates the audio level is below -40 dBFS.
- A 2 pixel high bar indicates an audio level greater than -40 dBFS but less than -35 dBFS.
- Audio peak levels in the range of -40 dBFS to -20 dBFS are displayed using 5 dB per pixel.
- Audio peak levels in the range of -20 dBFS to 0 dBFS are displayed starting at 6 pixels high and use additional pixels at a rate of 1 pixel every 2 dB.
- No meter bar indicates no valid input signal present on that AES/EBU stereo pair.

13.3 Resetting the Configuration to Default Settings

13.3.1 Resetting Audio Control Settings

Resets all mixer volumes and analog levels back to default settings. The Hono CobraNet interface stores audio control settings in flash memory so that they may be restored upon power up. To restore all control settings to factory defaults perform the following steps:



Navigate to the product information display using the select button.

1. Depress the select button. After 1 second you will see "RELEASE BUTTON TO: SAVE CONTROL SETTINGS". After about 3 seconds you will observe "RELEASE BUTTON TO: RESET CONTROL SETTINGS". Release the select button.
2. Power cycle the unit to cause controls to be restored to default settings.

13.3.2 Resetting Static IP Address

If you have configured the unit for a static IP address, you can reset it back to a dynamically assigned IP address using the following steps:

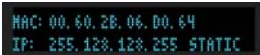

1. Navigate to the "MAC and IP address" display using the select button.
2. Depress the select button for more than 1 second. After you observe "RELEASE BUTTON TO: CLEAR STATIC IP," release the select button.

13.3.3 Resetting CobraNet Persistence

Resets all CobraNet Tx and Rx bundles to 0.

If you somehow get your Hono CobraNet interface into a state where you cannot communicate with it, the CobraNet persistence variable can be reset from the front panel of the unit. This may allow communication with the Hono CobraNet interface

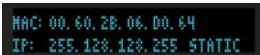

1. Navigate to the "MAC and IP address" display using the select button.
2. Depress the select button for more than 3 seconds. After you observe "RELEASE BUTTON TO: TURN PERSISTENCE OFF" release the select button.
3. Now that persistence is turned off, power cycle the Hono CobraNet interface. You should now be able to communicate with the device.

13.4 Network Interface

Hono CobraNet interface audio settings are configured over the network via UDP messages using port 44600. The unit's CobraNet networking settings are set using SNMP messaging. Both of these protocols require an IP address to be assigned to the unit.

13.4.1 Network Mask Assignment

The networking stack used for UDP messaging on each Hono CobraNet interface uses the following rules to automatically assign a NetMask:

Class A subnet: 1.0.0.0 - 127.0.0.0, Private allocation range: 10.0.0.0 - 10.255.255.255
NetMask : 255.0.0.0

Class B subnet: 128.0.0.0 - 191.255.0.0, Private allocation range: 172.16.0.0 - 172.31.255.255
NetMask : 255.255.0.0

otherwise
NetMask: 0.0.0.0

14 CONFIGURATION

14.1 ASIControl Configuration

ASIControl is available from the AudioScience Windows Driver's web page at AudioScience. It is embedded in AudioScience's standard audio drivers. If you are using an AudioScience CobraNet adapter or an AudioScience non-CobraNet audio adapter in the PC, choose the Wave, WDM, or Combo driver to download and install (the driver type to install will be dependant upon the application used with the AudioScience adapter; consult the manufacturer of the application). If you do not have an AudioScience adapter installed in the PC, simply download the Wave driver.

Run the driver .exe to install the driver components and be sure to select the second install option: "Standard PCI + Network Driver".

After driver installation, ASIControl can be run from either the desktop icon or from Start → All Programs → AudioScience → ASIControl.

If there is more than one NIC in the PC, upon startup, ASIControl will first prompt the user for which network interface to use to communicate with CobraNet devices. Next, to invoke the CobraNet Object Tools COM object to assign IP addresses to any CobraNet devices that do not currently have valid IP addresses, select Options→Configure CobraNet IP address range and fill in the range. (See the CobraNet section for further information.) Hono CobraNet interface communication with the host is via UDP messaging using port 44600.

To preserve control changes made to the Hono CobraNet interface, ASIControl must be shut down. This will save control settings to the unit's flash memory, allowing the settings to be restored after a power cycle.

14.1.1 ASIControl Layout

The screenshot shows the ASIControl (x64) application window. At the top, there is a table listing discovered CobraNet devices. Below this is a topology pane showing the inputs and outputs of the selected adapter. On the right, a node pane shows the controls for the selected node (Microphone 1).

Type	Index	Name	Serial...	Rev	Firmwa...	MAC Address	IP Address	sysDescription	sysName
	1100	ASD2416-4100	26752	C0	4.08.05	00.60.28.06.D0.64	192.168.1.5	AudioScience ASD2416 Modular In...	ASD2416
	1497	Hono CobraNet 8.0M	39291	D3	4.08.05	00.60.28.06.D1.F1	192.168.1.40	AudioScience Connect 8.0M Cobr...	Connect 8.0M
		CobraNet				00.60.28.06.D0.4C	192.168.1.3	AudioScience AS36416 PCI Cobra...	AS36416

Callout 1: List of CobraNet devices discovered on the network. Highlighted device is shown in the topology pane.

Callout 2: Topology pane showing the inputs and outputs of the selected adapter.

Callout 3: The node 1 Microphone 1 has been selected by left clicking with the mouse. Its controls show up in the node

Callout 4: Node pane shows the controls on the selected node; in this case 1 Microphone 1.

Figure 10. ASIControl layout

14.1.2 Adapter Information

This control displays information about the installed adapter or ASI2416.

14.1.2.1 Interface

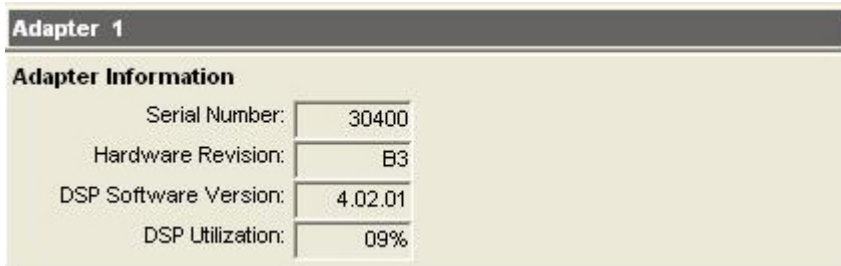

Figure 11. Adapter information seen in right side of ASIControl.

Serial Number:

The serial number is displayed here.

Hardware Revision:

This lists the hardware revision.

DSP Software Version:

The DSP software version is displayed; usually the same as the driver version installed.

DSP Utilization:

This shows the loading of the adapter's DSP in percent.

Note: Utilization should be kept below 90%.

14.1.3 Level

The levels in dBu for the adapter's line_outs and line_ins can be adjusted here.

In the example below, the Line_Out 1 node in the topology view of ASIControl has been selected. Its Level will show up on the right side of ASIControl. The same is done for a Line_In to see its Level.

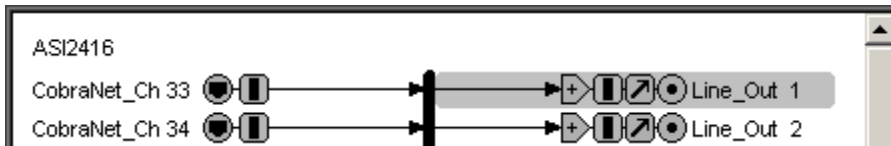



Figure 12. Using ASIControl to select Line_Out 1

14.1.3.1 Interface



Figure 13. Level displayed by ASIControl for Line_Out 1

Level:

The line out level can be adjusted by clicking the  arrows or by typing values in to set the appropriate level. Consult the specification section of this datasheet for the range of supported levels.

14.1.3.2 Developer

14.1.3.2.1 Windows APIs

Wave/Mixer – Analog levels are controlled using mixerSetControlDetails() on a control of type signed and with the name Level/Trim.

HPI – Analog levels are controlled using the [HPI_LevelSet\(\)](#) API.

ASX – Analog level are controlled using the [ASX_Level_Set\(\)](#) API.

DirectSound – TBD.

14.1.3.2.2 Linux APIs

HPI – Analog levels are controlled using the [HPI_LevelSet\(\)](#) API.

ASX – Analog level are controlled using the [ASX_Level_Set\(\)](#) API.

ALSA – TBD.

14.1.4 Meter

Meters in ASIControl are located on audio nodes and display the audio level as the audio signal passes through the node. Most AudioScience devices return both RMS and peak level readings and ASIControl displays both simultaneously.

14.1.4.1 Interface

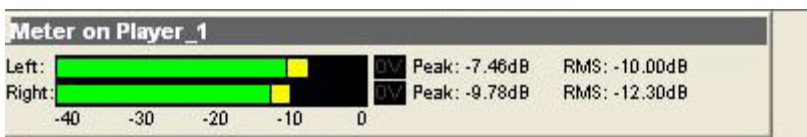

Figure 14. A stereo peak meter display; RMS is green and peak is yellow

To the right of the peak meter is the absolute readings in dBFS. These can be useful when testing input tones of a specific known level.

14.1.4.2 Developer

14.1.4.2.1 Windows APIs

Wave/Mixer – Meters are read using mixerGetControlDetails() on a control of type signed and with type “Peak” the name “Peak Meter”. A minimum value is 0 and maximum is 32767. The interface returns the peak readings only, not the RSM level. It confirms to expected Windows functionality.

HPI – Meters are read using the [HPI_Meterxxx\(\)](#) API.

ASX – Meters are read using the [ASX_Meter_xxx\(\)](#) API.

DirectSound – TBD.

14.1.4.2.2 Linux APIs

HPI – Meters are read using the [HPI_Meterxxx\(\)](#) API.

ASX – Meters are read using the [ASX_Meter_xxx\(\)](#) API.

ALSA – TBD.

14.1.5 Setting AES/EBU Clocking

The following diagram shows the sample rate-clocking scheme for AES/EBU Hono CobraNet interface models. For example, the Hono CobraNet 16/16D has stereo inputs and outputs 1-8, while the Hono CobraNet 8/8D model has inputs and stereo outputs 1-4. By default AES/EBU output clocking is set to the local module clock running at 44.1 kHz.

NOTE: Each AES/EBU input and output carries two channels of audio.

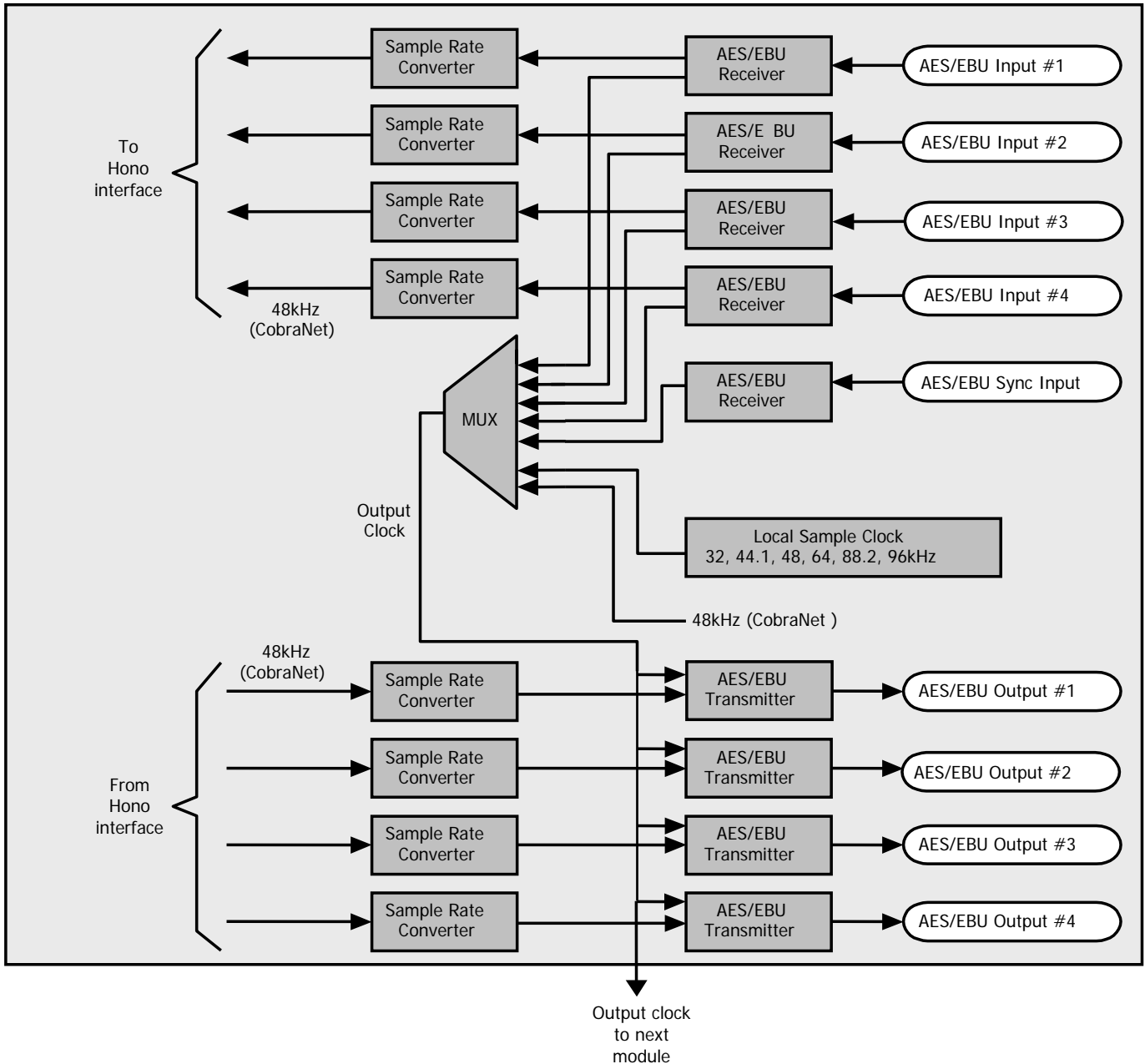

Figure 15. Hono CobraNet interface AES/EBU clocking for Module 1

The figure below highlights the fact that the Hono CobraNet interface can receive and transmit AES/EBU at almost any sample rate.

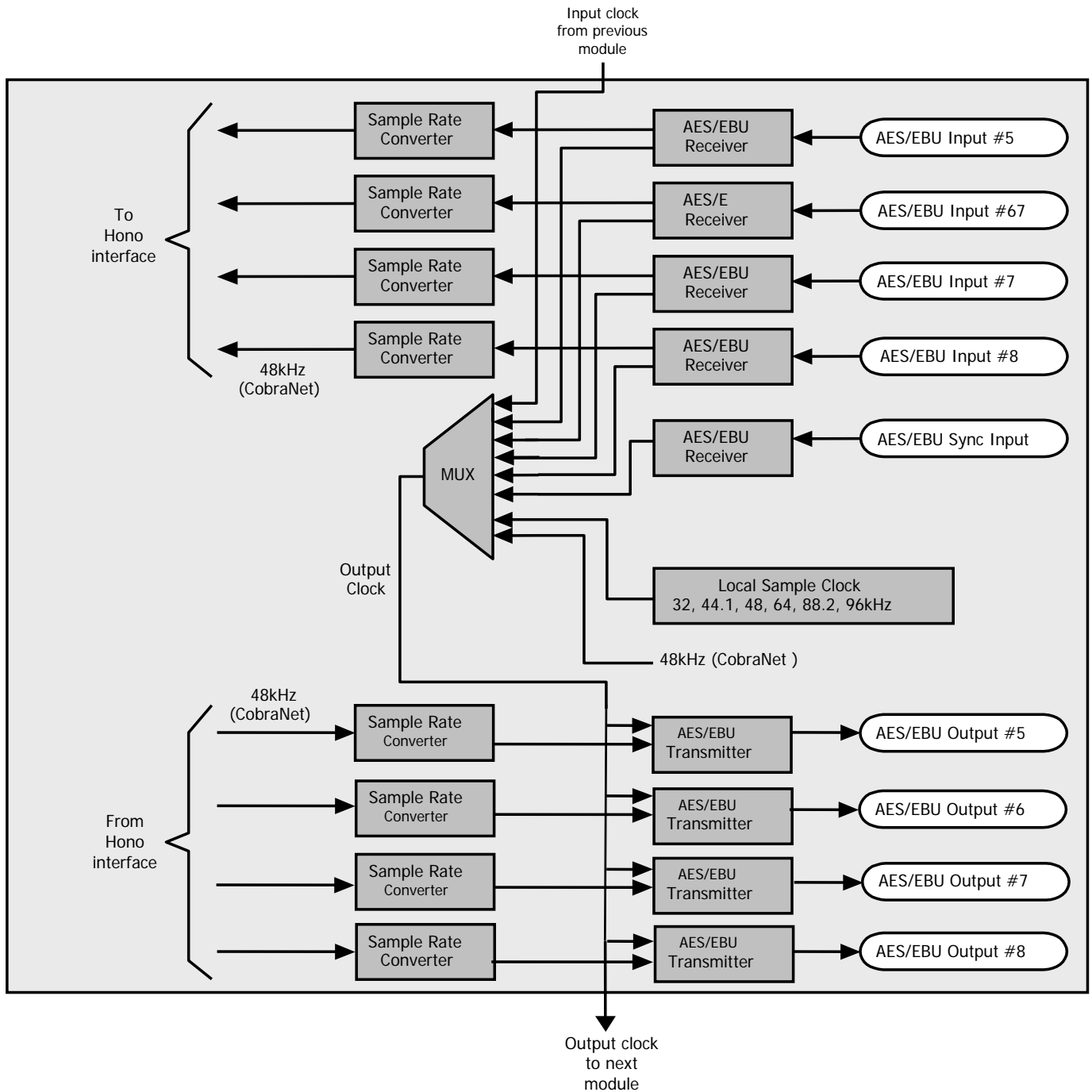

Figure 16. Hono CobraNet interface AES/EBU clocking for Module 2

14.1.5.1 AES/EBU Inputs

Each AES/EBU input has a sample rate converter (SRC) on it and so may have a sample rate that is asynchronous to the rest of the system. Valid sample rates are 32, 44.1, 48, 64, 88.2 and 96kHz.

There is nothing to set for the AES/EBU inputs since the sample rate conversion to the reference CobraNet clock takes place automatically in hardware.

14.1.5.2 AES/EBU Outputs

These are the five sample rate sources for clocking the AES/EBU outputs:

1. A sample rate from an (AES/EBU) module in the previous slot.
2. A sample rate derived from any of the four AES/EBU inputs on that module (32, 44.1, 48, 64, 88.2 or 96kHz)
3. A sample rate derived from the AES/EBU Sync input (32, 44.1, 48, 64, 88.2 or 96kHz)
4. A local sample rate clock that may be set to 32, 44.1, 48, 64, 88.2 or 96kHz.
5. The Hono CobraNet interface CobraNet clock (48kHz)

14.1.5.3 Setting the AES/EBU Tx clock source

The AES/EBU output clock is controlled by a Sample Clock control on the first output of each AES/EBU module. The first step in setting the AES/EBU output clocking is to select Line_Out 1 in ASIControl.

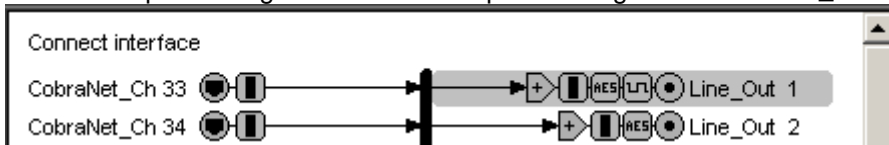

Figure 17. Selecting Line_Out 1 in ASIControl prior to setting Tx clock source

The node pane should now display the following:

Figure 18. ASIControl display of AES/EBU Line_Out 1 node controls

Click on the “Clock Source” combo box to select the desired source. See illustration below.

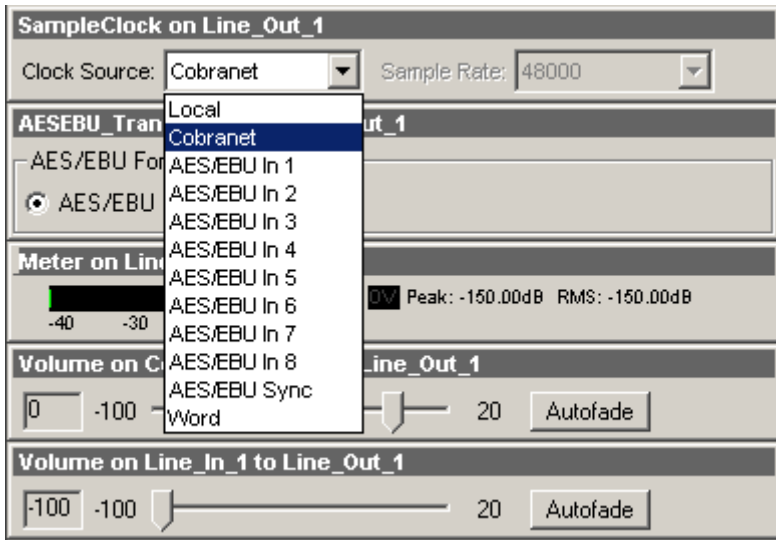

Figure 19. ASIControl selection of AES/EBU output clock source

Choose the desired clock source. Since AES/EBU inputs are actually stereo and come in on the same wires, the following inputs are paired together, and will use the same clock (1 & 2), (3 & 4), (5 & 6), (7 & 8).

The output clocking for the second set of 8 AES/EBU outputs is controlled independently from the first 8 outputs. It is accessed via Line_Out 9 (the first output on the second module). When clicking the “Clock Source” combo box for Line_Out 9 an additional option for “Previous Module” will be presented.

14.1.5.4 Common AES/EBU clocking configurations

This section outlines some common AES/EBU clocking configurations.

14.1.5.4.1 Everything running at 44.1 kHz local clock – no sync required

This is the default Hono CobraNet interface configuration. There is nothing to do.

14.1.5.4.2 All outputs running at AES/EBU house sync

Connect the house AES/EBU to the AES/EBU sync input of the first AES/EBU module. Using ASIControl set the SampleClock source to be “AES/EBU Sync”. This will sync all outputs on the first module to AES/EBU. To sync the outputs on the second module as well, go to Line_Out 9 and set the SampleClock source to “Previous Module”.

14.1.5.4.3 All outputs sync’d to one of the AES inputs

Connect the house AES/EBU to the AES/EBU sync input of the first AES/EBU module. Using ASIControl set the SampleClock source to be “AES/EBU In 1”. This will sync all outputs on the first module to AES/EBU In 1. To sync the outputs on the second module as well, go to Line_Out 9 and set the SampleClock source to “Previous Module”.

14.1.6 Input and Output Volume Adjustment

All outputs from the Hono CobraNet interface have volume adjustments in their path that support a range of -100 to + 20 dB. The nodes that support this are CobraNet_Ch 1-16 and Line_Out 1-16.

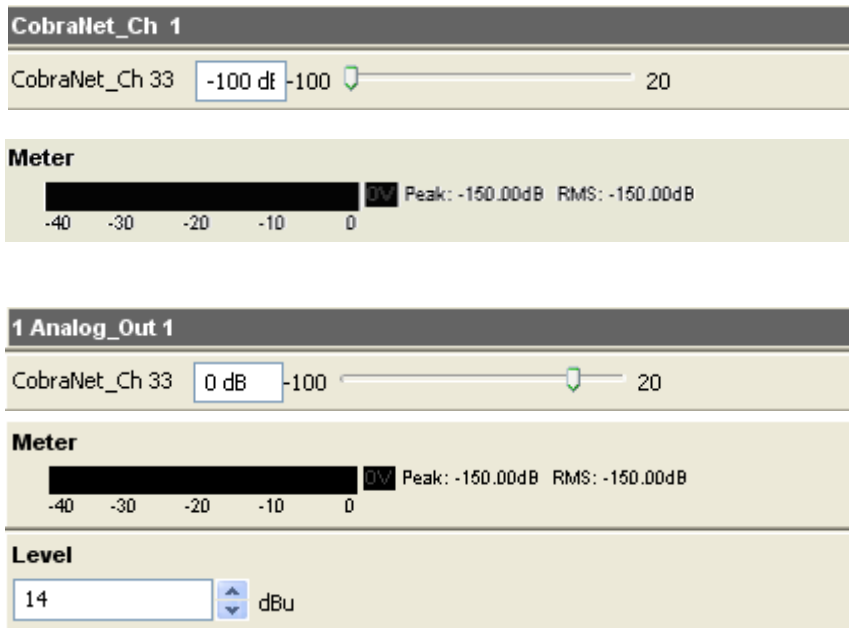

Clicking on CobraNet_Ch 1 in the topology pane of ASIControl will show a list of volumes in the node view pane. Below is an image of the first volume shown in the node pane. The meter is found after the list of volumes (the Hono CobraNet interface incorporates AudioScience's 'anything to anywhere) mixing).

Clicking on Analog_Out 1 in the topology pane of ASIControl will show a list of volumes in the node view pane. Below is an image of the first volume shown in the node pane. The meter and level is found after the list of volumes (the Hono CobraNet interface incorporates AudioScience's 'anything to anywhere' mixing).

Figure 20. ASIControl node displays with volumes

The volumes are self-explanatory. Just drag the sliders. All lineouts also have an audio path (with volume) from the corresponding line in. This can be use useful in verifying the correct operation of the audio modules without having to send the audio across a CobraNet network.

14.1.7 ClockSourceIn

In the topology pane of ASIControl, click on Clock Source 1



to see the ClockSourceIn information in the node pane.

14.1.7.1 Interface



Figure 21. Clock source information for CobraNet devices as seen in ASIControl

Clock Source:

CobraNet supports 48kHz. For this reason, the Clock Source is grayed out and is not user selectable.

Adapter Rate:

Displays CobraNet clock rate.

14.2 CobraNet Configuration

ASiControl can be used to configure both AudioScience CobraNet devices and third party CobraNet devices, via its CobraNet Configuration dialog box. This dialog box can be used to configure CobraNet devices and assign names, locations, bundle numbers, channel assignments, etc. Third party applications such as CobraNet Discovery can also be used to configure AudioScience CobraNet devices.

Below lists how to set up AudioScience’s software so ASiControl may be used to configure CobraNet.

NOTE: Under some Windows operating systems, ASiControl must be run as administrator in order to see all networked CobraNet devices. In Windows 7 this is done by right clicking on the ASiControl shortcut on the desktop and selecting “Run as administrator.”

NOTE: Some antivirus programs and/or firewalls can prevent ASiControl from showing all CobraNet devices on a CobraNet network. If all CobraNet devices are not showing in the top pane of ASiControl, please check settings and/or turn off any antivirus programs or firewalls that may be running on the PC.

14.2.1 Setting Up AudioScience Software to Configure CobraNet

14.2.1.1 Setting Up AudioScience Software Using a PC

To configure AudioScience Hono CobraNet devices using ASiControl, the following must be in place: the AudioScience network driver must be installed on a PC (this PC will run ASiControl), the networked adapters option must be selected in ASiControl, the Hono CobraNet device must be connected to the CobraNet network via an Ethernet cable, and the PC that is running ASiControl must also be connected to the same CobraNet network. The steps below describe how to do this.

14.2.1.1.1 Install the Network Driver

When an AudioScience driver install EXE is run, three choices are made available as shown in the image below. Select “Install Standard + Network Audio Driver” when installing AudioScience CobraNet products, then run the driver install EXE as usual.

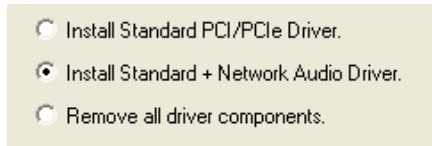

14.2.1.1.2 Select Networked Adapters in ASIControl

In ASIControl, go to the menu item Options, then select Configure adapter interface, as shown below.

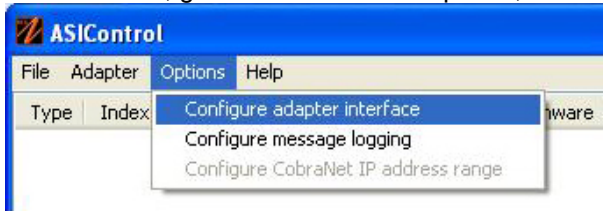

Since ASIControl is used for both AudioScience’s non-CobraNet adapters and CobraNet adapters, the correct interface must be selected when using ASIControl for CobraNet configuration. Click on menu item Options, then Configure adapter interface. The Interface Selection dialog box opens; the default selection is “Local PCI(e) adapters. Select ‘Local PCI(e) + Networked adapters.’ then click OK.



ASIControl will restart, looking for all CobraNet devices on the network, assigning IP addresses where needed, and showing CobraNet devices on the network in its top pane.

14.2.1.1.3 Connect CobraNet Device to the Network

Plug one end of an Ethernet cable into the back of the AudioScience CobraNet device. Plug the other end into the CobraNet or test network.

14.2.1.2 Setting Up AudioScience Software Using a Laptop

The Hono CobraNet interface can be configured using a laptop and an Ethernet crossover cable. Follow the steps above to install the AudioScience network driver must be installed on the laptop, then connect the laptop to the Hono CobraNet device using an Ethernet crossover cable. The laptop’s network adapter must have a static IP address.

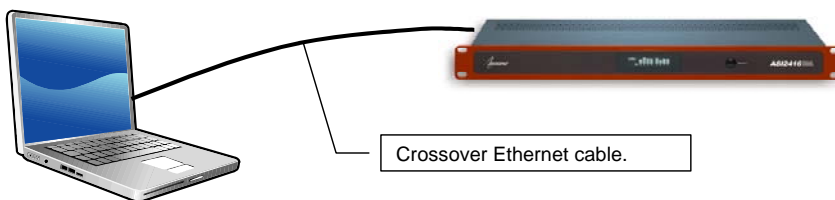
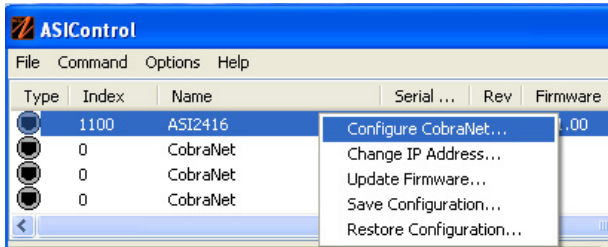

Figure 22. Laptop to Hono CobraNet interface connection

14.2.2 Configuring CobraNet Using ASIControl

The CobraNet Configuration dialog box is accessed via ASIControl, which is installed when the driver EXE is run. Double click on the ASIControl icon on the desktop, then in the top section right click on the CobraNet device and select Configure CobraNet... (see further for information on the other selections available):



The CobraNet Configuration dialog box opens:

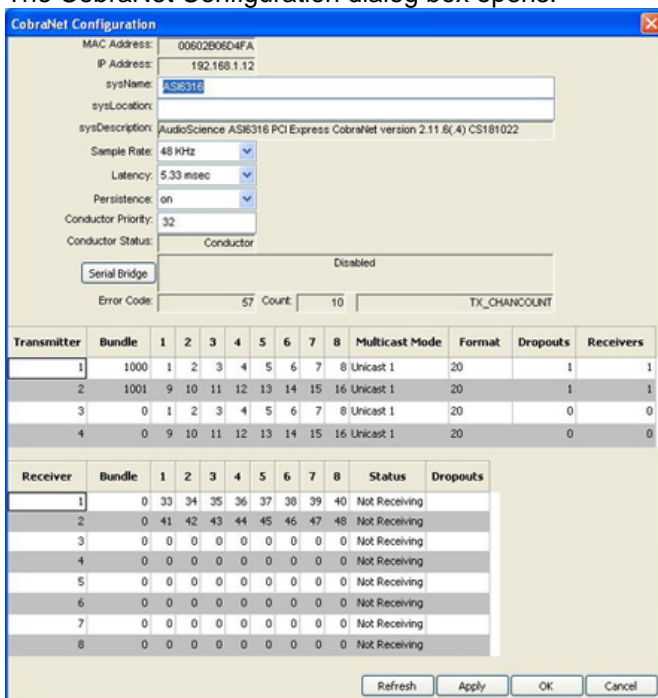

Figure 23. ASIControl's Configure CobraNet

14.2.2.1 CobraNet Configuration Dialog Box

There are three main sections of the dialog box: the top shows the **configuration section** of the CobraNet device, the **transmitter section** is in the middle, and the **receiver section** is at the bottom. There are also four user control buttons on the bottom right.

14.2.2.1.1 Configuration Section

MAC Address:

Read only; displays the MAC address of the CobraNet device.

IP Address:

Read only; displays the assigned IP address of the CobraNet device.

sysName:

Editable; a meaningful name can be given to a CobraNet device here. The default setting will be the name of the CobraNet device; for example "Hono CobraNet 8.8M."

sysLocation:

Editable; a physical location can be listed here for ease of reference. The default setting is blank.

sysDescription:

Read only; lists the type of CobraNet interface. The default setting will be the full name a CobraNet version number of the CobraNet device, for example "AudioScience Hono CobraNet 8.8M version 2.11.4(.3) CS181022."

Sample Rate:

Default setting is 48kHz ; a CobraNet device must run at one sample rate only. Two CobraNet devices on the same network can each operate at a different sample rate.

Latency:

Choose between 1.33, 2.67, or 5.33 ms (default setting).

Persistence:

Default is 'off.'). In most real world deployments the persistence bit should be set to on so that the Hono CobraNet device will remember its CobraNet settings and IP address in the event of a power cycle. If the persistence bit is left off, bundle numbers, sysName, and sysLocation will be set back to default values on power cycle.

Conductor Priority:

Editable; set a low number to ensure the CobraNet device will always be a Performer (it will never be a Conductor) or set it to a high number to ensure it will always be a Conductor (it will never be a Performer). The following are Cirrus numbering conventions:

- 0 = never conductor
- 32 = normal conductor priority (the CobraNet device will either be the Conductor or the Performer)
- 128 = high conductor priority (the CobraNet device will be the Conductor)

Conductor Status:

Read only; displays if the CobraNet device is a Conductor or Performer.

Error Code:

Displays CobraNet-specific error information using Cirrus' error numbering conventions.

Count:

Displays the number of errors that have occurred on the device. Some errors result from normal operation; disconnecting cables, rerouting, etc. The text field to the right of Count displays the Cirrus-related text.

14.2.2.1.2 Transmitter Section

The Hono CobraNet devices will have the following transmitter defaults:

Transmitter	Bundle	Ch 1 map	Ch 2 map	Ch 3 map	Ch 4 map	Ch 5 map	Ch 6 map	Ch 7 map	Ch 8 map	Format	Count	UniCast Mode
TX1	0	1	2	3	4	5	6	7	8	20 bits	8	Never
TX2	0	9	10	11	12	14	14	15	16	20 bits	8	Never
TX3	0	1	2	3	4	5	6	7	8	20 bits	8	Never
TX4	0	9	10	11	12	14	14	15	16	20 bits	8	Never

Information on the Transmitter section as seen in ASIControl's Configure CobraNet dialog box:

Transmitter:

Sends an audio bundle, made up of up to 8 audio channels, to a CobraNet receiver on the network.

Bundle:

The basic CobraNet audio routing component, can have 0 to 8 audio channels. Assign specific bundle numbers here.

Bundle numbers can be 0 and 1 – 65535

- 0 for turning transmitter off or for silence
- 1-255 for multicast
- 256-65279 for unicast
- 65280-65535 for private

1-8 Audio Channels:

The number of mapped channels from mixer to transmitter. Channels 0 (inactive) and 1-32 can be assigned. A 0 mapping of end channels 'shortens' the bundle; a mapping of 0 in the middle of mapping denotes silence.

Multicast Mode:

Double click to change setting in the dropdown list; use the following table to determine what setting to select:

Settings	Number of Receivers <= N	Number of Receivers > N
Multicast Bundle # < 256	Multicast	Multicast
Always	Multicast	Multicast
Unicast N	Unicast	Unicast if Receiver = 1-N Fail if Receiver > N
Multicast Over N	Unicast	Multicast

Information on the Receiver section as seen in ASIControl's Configure CobraNet dialog box:

Format:

Double click to change the audio sample format to 16, 20, or 24 bits.

Dropouts:

The number of times the channel transmission has been interrupted. Interruptions can be caused by loss of transmit permission from conductor (i.e. conflict with another transmitter set to the same bundle number) or by changes to txBundle.

Receivers:

The number of receivers requesting this bundle.

14.2.2.1.3 Receiver Section

The Hono CobraNet devices will have the following receiver defaults:

Receiver	Bundle	Ch 1 map	Ch 2 map	Ch 3 map	Ch 4 map	Ch 5 map	Ch 6 map	Ch 7 map	Ch 8 map	Format
RX1	0	33	34	35	36	37	38	39	40	undefined
RX2	0	41	42	43	44	45	46	47	48	undefined
RX3	0	0	0	0	0	0	0	0	0	undefined
RX4	0	0	0	0	0	0	0	0	0	undefined
RX5	0	0	0	0	0	0	0	0	0	undefined
RX6	0	0	0	0	0	0	0	0	0	undefined
RX7	0	0	0	0	0	0	0	0	0	undefined
RX8	0	0	0	0	0	0	0	0	0	undefined

Receiver:

Can receive from a CobraNet transmitter on the network one bundle made up of up to 8 audio channels.

Bundle:

The basic CobraNet audio routing component; assign a specific Bundle number here. A Receiver can carry 0 (channel will not be mapped to mixer) to 8 audio channels.

1-8 Audio Channels:

The number of audio channels in the bundle to be routed to the particular Receiver; channels 0 (inactive) and 33-64 can be assigned.

Status:

Displays 'Receiving' when a bundle is successfully routed to it.

Dropouts:

Displays number of times bundle reception has been interrupted. Interruptions can be caused by transmitter failure or by reconfiguring the receiver.

14.2.2.1.4 User Control Buttons

Refresh:

Updates fields and statuses. If clicked before Apply, clears any changes made.

Apply:

Accepts changes and leaves dialog box open.

OK:

Accepts changes and closes dialog box.

Cancel:

Does not accept any changes made and closes dialog box.

14.2.2.2 How To Configure and Transmit a Bundle

The minimum configuring needed to test basic functionality of sending and receiving a bundle is to set a transmitter bundle and channels on one CobraNet device, and then set the receiver of another CobraNet device to the same bundle number, plus assign its channel numbers.

For example, an ASI6416 is installed in a computer, ASIControl is opened and is used to play a stereo audio file in the ASI6416's Player 1. The Repeat box is checked to have continuous audio playing.

ASIControl is then used to set the ASI6416's first transmitter to have bundle number and channel assignments. Double clicking in receiver 1's bundle field makes it editable and 255 (for example) is typed in. Double clicking in the receiver 1, channel 1 box makes it editable and 1 is typed in (numbers 0 and 1-32 can be used). Hitting the Tab key auto fills the rest of the channels. Since only two channels are needed, double clicking in the channel 3 box, typing in 0, and then hitting the Tab key changes channels 3-8 to have 0s in them. The OK button is clicked and the dialog box closes.

On the same CobraNet network is an ASI2416. Its CobraNet Configuration dialog box is opened using ASIControl. Using the same procedures as above, 255 is typed in (since 255 was used in the example above) as the bundle number for the ASI2416's receiver 1, and its first two channels are assigned numbers 33 and 34 (numbers 0 and 33-64 can be used). This time the Apply button is clicked so the dialog box remains open. Immediately in the CobraNet Configuration dialog box the first two channels in receiver 1 turn green and the Status field changes to 'Receiving' to indicate a bundle has been successfully routed to the receiver. If any errors, the receivers would turn red.

Clicking OK closes the CobraNet Configuration dialog box. ASIControl is still open and meter movement is seen in CobraNet_Ch 33 and 34, as well as Line_Outs 1 and 2.

14.2.3 References

http://cirrus.com/en/pubs/appNote/CobraNet_AudioRoutingPrimer.pdf

http://cirrus.com/en/pubs/manual/CobraNet_Programmer_Manual_PM25.pdf

http://www.cirrus.com/en/support/cobranet/design/switched_networks.html

14.3 Network Configuration

14.3.1 Change IP Address

Change the IP address of a CobraNet device here.

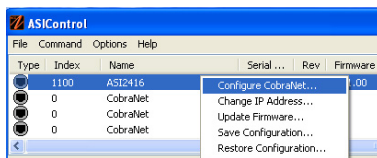

After right clicking on a CobraNet device in ASIControl and selecting "Change IP Address...", the dialog box below opens.

14.3.1.1 Interface

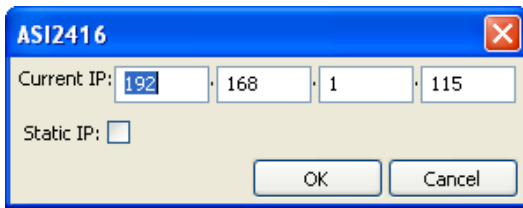

Current IP:

The CobraNet device's current IP address is shown. Double click in the fields to highlight the current number and overwrite it.

Static IP:

It is recommended to click on the Static IP checkbox to have a fixed IP address.

OK/Cancel:

Click OK to accept the changes and close the dialog box, or Cancel to not accept any changes and close the dialog box.

14.3.2 Configure Network Interface and Auto-IP Assignment Range

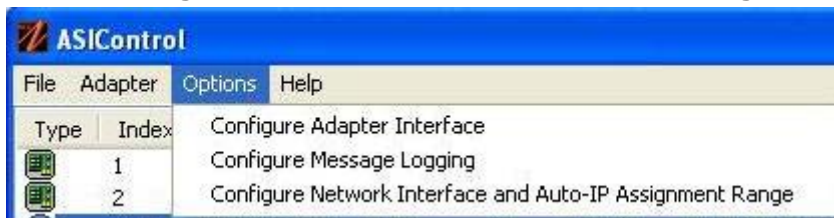

The network interface and the auto-IP assignment range are grouped under Options→Configure Network Interface and Auto-IP Assignment Range. Clicking on it opens the ASIControl – choose network interface dialog box.

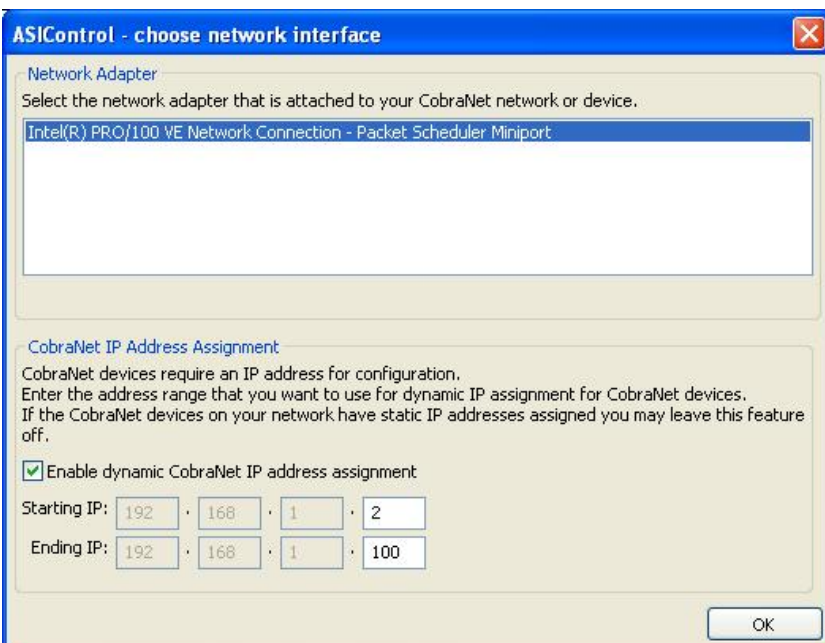

From this dialog box, choose the network adapter to use (if two or more NICs are in the machine).

Check the Enable dynamic CobraNet IP address assignment checkbox, if required. This allows input in the last box of the Starting IP and Ending IP range. Type in the numbers required and click OK.

Figure 24. ASIControl network adapter and IP address assignments

<end>