

1 DESCRIPTION

The Hono CobraNet 2.2D is a CobraNet interface in the Hono CobraNet Mini series designed for use in the professional installed sound market. The Hono CobraNet 2.2D receives eight channels of CobraNet and sends them to one AES/EBU output (2 channels) while simultaneously inputting two channels of audio from one AES/EBU input and transmitting them as eight channels of CobraNet. The Hone CobraNet 2.2D is perfect for applications requiring additional inputs or outputs to an existing CobraNet system.

2 FEATURES

Inputs

- One AES/EBU
- Sample Rate Converters
- 3.81mm pluggable terminal block connectors

Outputs

- One AES/EBU
- Sample Rate Converters
- 3.81mm pluggable terminal block connectors

GPIO

- Two opto-isolated inputs
- Two normally open relay isolated outputs

CobraNet

- Redundant CobraNet
- Four channels of CobraNet in and out
- Four CobraNet transmitters and eight receivers

DSP

- Peak and RMS meters on all audio inputs and outputs
- Mixing of any input to any output
- Programmable delay on all audio outputs
- Silence detect on all audio outputs
- Scripting support

Power

- Power over Ethernet (PoE) 802.3af compliant
- External +5V power supply if POE not being used

Chassis

- Rack mountable using optional 1U front panel
- Wings allow easy mounting
- 5.25 inches W x 3.125 inches L x 1.37 inches H

Control

- ID switches assign the CobraNet SNMP SysName variable to uniquely identify each unit on the network
- All settings adjustable from ASIControl software

3 ARCHITECTS AND ENGINEERS SPECIFICATION

The CobraNet interface shall provide one AES/EBU (2 channels) audio input and one AES/EBU (2 channels) audio output on plug in terminal block connectors. The CobraNet interface shall provide front panel meters to monitor the input and output signals. Four channels of redundant CobraNet input and output shall be provided on an RJ-45 connector. The CobraNet interface shall be compatible with the AudioScience ASIControl software for configuration and monitoring. The CobraNet interface shall be powered by IEEE 802.3af Power-over-Ethernet or from an external +5VDC @ 10W power supply. The CobraNet interface shall be compliant with CE, FCC part 48 and the RoHS directive. Warranty shall be 3 years. The CobraNet interface shall be the AudioScience Hono CobraNet 2.2D.

4 SPECIFICATIONS

COBRANET INPUT/OUTPUT

Type	100BaseT Ethernet
Connector	RJ-45
Precision	16, 20 or 24bit PCM
Sample Rate	48kHz
Latency	1.33, 2.66 or 5.33ms
Control Protocol	SNMP

INPUT

Type	AES/EBU (EIAJ CP-340 Type I / IEC-958 Professional)
Connector	Terminal block
Input Impedance	110 Ohms
Dynamic Range ^[1]	125dB, any input to any output
THD+N ^[2]	125dB, any input to any output
Sample Rate	32, 44.1, 48, 96 and 192kHz
Frequency Response	20Hz to 20kHz +/-25dB

OUTPUT

Type	AES/EBU (EIAJ CP-340 Type I / IEC-958 Professional)
Connector	Terminal block
Output Impedance	110 Ohms
Dynamic Range[1]	125dB, any input to any output
THD+N[2]	125dB, any input to any output
Sample Rate	48kHz.
Frequency Response	20Hz to 20kHz +/-0.25

LATENCY (48kHz CobraNet)	5.33ms CobraNet latency	2.67ms CobraNet latency	1.33ms CobraNet latency
AES/EBU input across network to AES/EBU out	11.55ms	8.89ms	7.55ms
CobraNet input to AES/EBU Out	6.83ms	4.17ms	2.83ms
AES/EBU input to CobraNet output	10.05ms	7.39ms	6.05ms
AES/EBU input to AES/EBU output	4.55ms		

GP OPTO-ISOLATED INPUTS

Isolation	2000VRMS
Input Drive	4mA typical with internal 5V supply and internal 1K current limiting resistor
Network protocol	AudioScience HPIUDP

GP RELAY OUTPUTS

Isolation	1500VRMS between relay contacts and coil
Contact Rating	Up to 200VDC and 500mA, 10W maximum
Network protocol	AudioScience HPIUDP

GENERAL

Dimensions	6.50"W x 3.125"D x 1.90"H (165mm x 80mm x 48mm)
Weight	24oz, 710g
Operating Temperature	0C to 45C ambient, assuming still air.
Power Requirements	IEEE 802.3af Power-over-Ethernet Class 0 or External +5VDC @ 2A power supply (supplied)
Certifications	CE: EN55103 FCC: Part 15 Subpart B Class A

[1] - Dynamic range measured with a -60dBfs sine wave and A weighting filter and 20-20kHz b/w

[2] - THD+N measured using a -1dBfs 1kHz sine wave sampled at 48kHz, 20-20kHz b/w and A weighting filter

[3] - With Zs = 150ohms and Input level set to -10dBu

5 BLOCK DIAGRAM

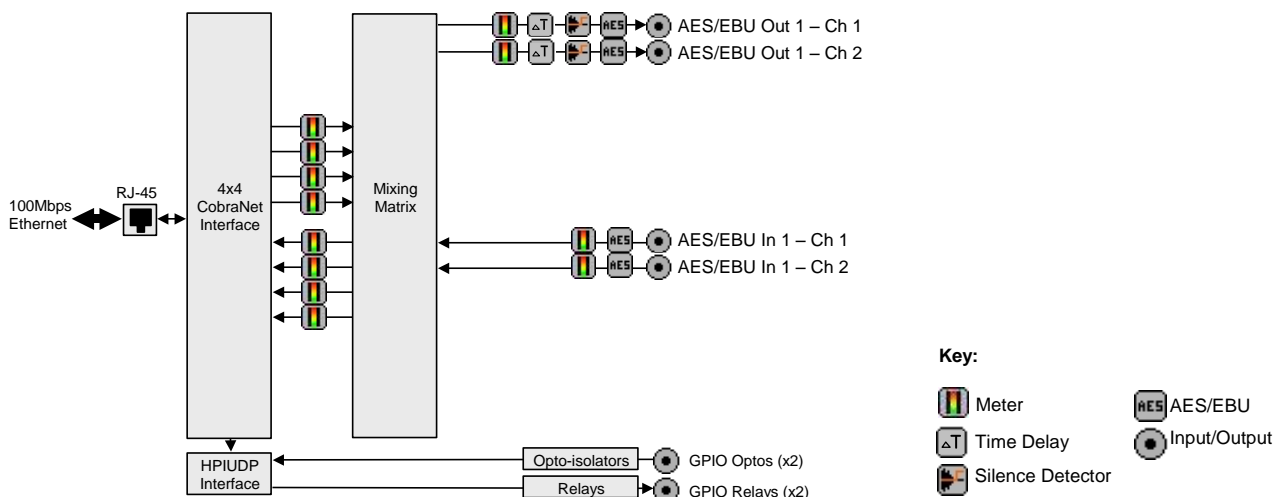

6 REVISIONS

Date	Description
November 28 2011	Preliminary
May 15, 2012	Added section for mic/line in settings

7	CONTENTS	
1	DESCRIPTION	1
2	FEATURES	1
3	ARCHITECTS AND ENGINEERS SPECIFICATION	1
4	SPECIFICATIONS	2
5	BLOCK DIAGRAM	2
6	REVISIONS	3
7	CONTENTS	4
8	TABLE OF FIGURES	5
9	IMPORTANT SAFETY INSTRUCTIONS	6
10	NOTICES	7
11	INTRODUCTION	8
12	FRONT AND BACK PANELS	9
12.1	FRONT PANEL	9
12.1.1	ADAPTER ID rotary switches	9
12.1.2	POWER LED	9
12.1.3	IP LED	9
12.1.4	STATUS LED	9
12.1.5	METER LEDS	9
12.1.6	CLEAR SETTINGS button	10
12.2	BACK PANELS	10
12.2.1	OUT 1..4	11
12.2.2	IN 1..4	11
12.2.3	GPIO – RELAYS	11
12.2.4	GPIO-OPTOS	11
12.2.5	RJ45 – PRIMARY+PoE	11
12.2.6	RJ45 – SECONDARY	11
12.2.7	5V DC Jack	11
13	HARDWARE INSTALLATION	11
13.1	MOUNTING	11
13.1.1	Flange Mounting	11
13.1.2	Rack Mounting	11
13.2	ETHERNET CONNECTION	12
13.2.1	PoE Power	12
13.2.2	External +5V Power	12
14	OPERATION	12
14.1	POWER UP SEQUENCE	12
14.1.1	Power	12
14.1.2	Firmware images	12
14.1.3	Firmware loading sequence	12
14.1.4	Loading the factory firmware image	13
14.2	RESETTING THE CONFIGURATION TO DEFAULT SETTINGS	13
14.2.1	Resetting Audio Control Settings	13
14.2.2	Resetting Static IP Address	13
14.2.3	Resetting CobraNet Persistence	13
14.3	NETWORK INTERFACE	13
14.3.1	Network Mask Assignment	13

15 CONFIGURATION	14
15.1 ASICONTROL CONFIGURATION.....	14
15.1.1 ASIControl Layout.....	14
15.1.2 About.....	15
15.1.3 Status.....	15
15.1.4 Level.....	16
15.1.5 Meter.....	16
15.1.6 AES/EBU I/O.....	17
15.1.7 Input and Output Volume Adjustment.....	17
15.1.8 Audio Delay.....	18
15.1.9 Signal Generator.....	19
15.2 MIC/LINE INPUT CONFIGURATION.....	20
15.2.1 Phantom Power.....	20
15.2.2 Input Level.....	20
15.2.3 Parametric Equalizer.....	20
10.2.3.1 Interface.....	21
10.2.3.2 Developer.....	22
15.2.4 Compressor/Limiter.....	22
15.3 ACCESS CONTROL USING PASSWORDS.....	23
15.4 GPIO.....	26
15.4.1 Outputs.....	26
15.4.2 Inputs.....	26
15.5 COBRANET CONFIGURATION.....	28
15.5.1 Setting Up AudioScience Software to Configure CobraNet.....	28
15.5.2 Configuring CobraNet Using ASIControl.....	30
15.5.3 References.....	34
15.6 NETWORK CONFIGURATION.....	34
15.6.1 Change IP Address.....	34
15.6.2 Configure Network Interface and Auto-IP Assignment Range.....	35
16 APPENDIX 1 COBRANET	36
16.1 COBRANET™.....	36
16.2 COBRANET ROUTING.....	36
16.2.1 Audio Routing Channels.....	37
16.2.2 CobraNet Transmitters.....	38
16.2.3 CobraNet Receivers.....	38
16.2.4 CobraNet Sample Rate and Latency.....	38
16.2.5 CobraNet References.....	38

8 Table of Figures

Figure 1. Hono Mini CobraNet Mini interface block diagram.....	8
Figure 2. ASIControl layout.....	15
Figure 3. Adapter About information seen in right side of ASIControl.....	15
Figure 4. The Status user interface.....	15
Figure 5. Using ASIControl to select Analog_Out 1.....	16
Figure 6. Level displayed by ASIControl for Line_Out 1.....	16
Figure 7. A stereo peak meter display; RMS is green and peak is yellow.....	17
Figure 8. ASIControl node displays with volumes.....	18
Figure 9. Internal node as seen in ASIControl.....	19
Figure 10. Signal Generator User Interface as seen in ASIControl.....	19
Figure 14. Laptop to Hono Mini CobraNet interface connection.....	29
Figure 15. ASIControl's Configure CobraNet.....	30
Figure 16. ASIControl network adapter and IP address assignments.....	35
Figure 17. Illustration of a CobraNet bundle going between two CobraNet devices.....	36
Figure 18. Audio routing channel details.....	37

9 IMPORTANT SAFETY INSTRUCTIONS

1. Read these instructions.
2. Keep these instructions.
3. Read all warnings.
4. Follow all instructions.
5. Do not use this apparatus near water.
6. Clean only with a dry cloth.
7. Do not block any ventilation openings. Install in accordance with these instructions.
8. Do not install near any heat sources such as radiators, heat registers, stoves, or other apparatus (including amplifiers) that produce heat.
9. Protect the power supply cord from being walked on or pinched, particularly at plug ends, convenience receptacles, and the point where they exit from the apparatus.
10. Only use attachments/accessories specified by the manufacturer.
11. Unplug this apparatus during lightning storms or when unused for long periods of time.
12. Refer all servicing to AudioScience. Servicing is required when the apparatus has been damaged in any way, such as power-supply cord or plug is damaged, liquid has been spilled or objects have fallen into the apparatus, the apparatus has been exposed to rain or moisture, does not operate normally, or has been dropped.

10 NOTICES

FEDERAL COMMUNICATIONS COMMISSION (FCC) INFORMATION

NOTE: This equipment has been tested and found to comply with the limits for a Class A digital device, pursuant to Part 15 of the FCC Rules. These limits are designed to provide reasonable protection against harmful interference in a commercial installation. This equipment generates, uses, and can radiate radio frequency energy and, if not installed and used in accordance with the instructions, may cause harmful interference to radio communications. Operation of this equipment in a residential area is likely to cause harmful interference, in which case the user will be required to correct the interference at his or her own expense.

lwIP

lwIP is licensed under the BSD license:
 Copyright (c) 2001-2004 Swedish Institute of Computer Science.
 All rights reserved.

Redistribution and use in source and binary forms, with or without modification, are permitted provided that the following conditions are met:

1. Redistributions of source code must retain the above copyright notice, this list of conditions and the following disclaimer.
2. Redistributions in binary form must reproduce the above copyright notice, this list of conditions and the following disclaimer in the documentation and/or other materials provided with the distribution.
3. The name of the author may not be used to endorse or promote products derived from this software without specific prior written permission.

THIS SOFTWARE IS PROVIDED BY THE AUTHOR "AS IS" AND ANY EXPRESS OR IMPLIED WARRANTIES, INCLUDING, BUT NOT LIMITED TO, THE IMPLIED WARRANTIES OF MERCHANTABILITY AND FITNESS FOR A PARTICULAR PURPOSE ARE DISCLAIMED. IN NO EVENT SHALL THE AUTHOR BE LIABLE FOR ANY DIRECT, INDIRECT, INCIDENTAL, SPECIAL, EXEMPLARY, OR CONSEQUENTIAL DAMAGES (INCLUDING, BUT NOT LIMITED TO, PROCUREMENT OF SUBSTITUTE GOODS OR SERVICES; LOSS OF USE, DATA, OR PROFITS; OR BUSINESS INTERRUPTION) HOWEVER CAUSED AND ON ANY THEORY OF LIABILITY, WHETHER IN CONTRACT, STRICT LIABILITY, OR TORT (INCLUDING NEGLIGENCE OR OTHERWISE) ARISING IN ANY WAY OUT OF THE USE OF THIS SOFTWARE, EVEN IF ADVISED OF THE POSSIBILITY OF SUCH DAMAGE.

11 INTRODUCTION

The Hono Mini CobraNet Mini series of products are CobraNet™ audio interfaces providing 8 channels of CobraNet receive and transmit.

Various models provide up to 4 channels of microphone/line in and line out or up to 4 channels of AES/EBU I/O. Each input and output is configured with a pluggable terminal block (Phoenix type) connector).

Additionally each model contains GPIO. The GPIO inputs are opto-isolated and the GPIO outputs are relay based.

The Hono Mini CobraNet Mini interfaces features a powerful Texas Instruments 32bit floating point DSP that allows sophisticated switching and mixing. LED displays on the unit's front panel shows peak meters and CobraNet status.

The units maybe powered using Power-over-Ethernet (PoE) from the primary Cobranet port or from an external +5V power supply.

AudioScience provides application software that may be used to set up the Hono Mini CobraNet Mini interfaces. ASIControl can be used to set all internal features of the unit (such as levels) and to set CobraNet routing connections to be set up between the Hono Mini CobraNet interfaces and any other compliant CobraNet device on the network.

The following table lists the Hono Mini CobraNet Series and a description of each unit.

Model	Network Protocol	Description
Hono Mini CobraNet 2.2M	CobraNet	2 channels of balanced analog mic/line inputs, line outputs
Hono Mini CobraNet 4.4M	CobraNet	4 channels of balanced analog mic/line inputs, line outputs
Hono Mini CobraNet 2.2D	CobraNet	2 channels of AES/EBU inputs/outputs
Hono Mini CobraNet 4.4D	CobraNet	4 channels of AES/EBU inputs/outputs

Below is a block diagram of the Hono Mini CobraNet Mini interface. Different models will have different configurations of the audio I/O, per the above table.

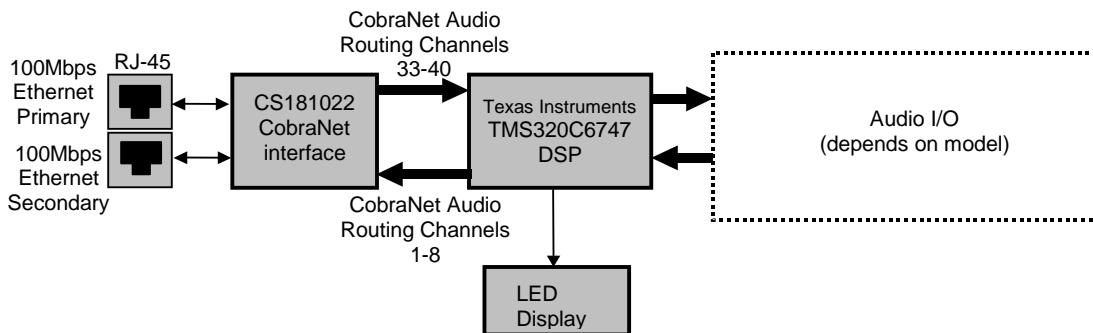
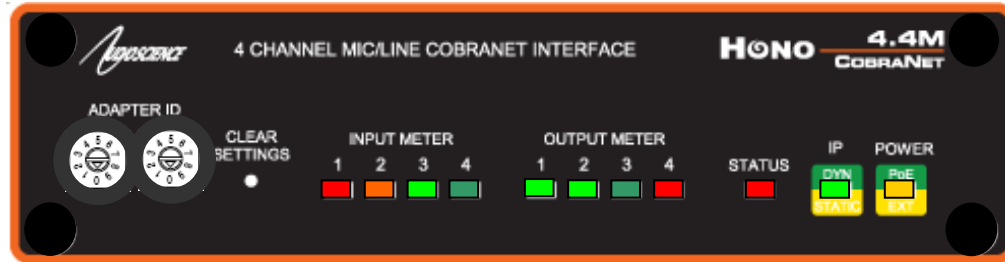

Figure 1. Hono Mini CobraNet Mini interface block diagram

12 FRONT AND BACK PANELS

12.1 Front Panel

The following diagram shows the front panel of the 4.4M. The 2.2M, 2.2D and 4.4D are similar, except that the 2.2M & 2.2D only have two input and two output meters.



12.1.1 ADAPTER ID rotary switches

The two rotary switches allow an Adapter ID of 01 to 99 to be entered. When set to 00, the units Adapter ID is set to its default (based on its MAC address). When set to 1 to 99, that number is used as an offset to the adapter ID of 100, i.e 101 to 199.

12.1.2 POWER LED

- **Green** when running from Power over Ethernet (PoE). Note, PoE is only available from the primary [CobraNet](#) RJ45.
- **Orange** when running from the external +5V DC source.
- **Orange + Green** when both present.

12.1.3 IP LED

- **Green** when an IP address has been obtained from a DHCP server or from autoip.
- **Orange** when a static IP address is configured.
- **Orange Blinking** when the unit does not have an IP address.

12.1.4 STATUS LED

- **Green** when everything is OK.
- **Orange** when the unit is running from its factory (backup) firmware.
- **Red Blinking** when there is an error.

12.1.5 METER LEDS

- Normally represent the audio level at the Analog or AES/EBU inputs and outputs. Dim green represents a peak level of around -40 dBFs, while red represents -1dBFs. Bright red indicates 0dBFs or overload condition. When an overload condition occurs, the meter will remain bright red for 1 sec before resuming normal metering.
- During firmware update, all **Red Blinking** during flash erase, then show progress during flash write.
- Short button presses using CLEAR SELECT change what is displayed:
 1. The 8 [CobraNet](#) input levels
 2. The 8 [CobraNet](#) output levels

3. The state of 4 GPIO **inputs** and 4 GPIO **outputs**
 4. Back to the local audio I/O.
- Revert to displaying local I/O levels after 10 seconds in any case.

12.1.6 CLEAR SETTINGS button

- When pressed during startup, the factory default firmware will be loaded (the 2nd copy stored on the unit).
- Short press (less than one second) switches between meter displays (see METER LEDS).
- Long press (between 1 and 3 seconds) enters menu mode.
- Very long press (more than 3 seconds) resets the display to default metering.

12.2 Back Panels

The following diagram shows the back panel of the 2.2M, 4.4M, 2.2D, 4.4D.

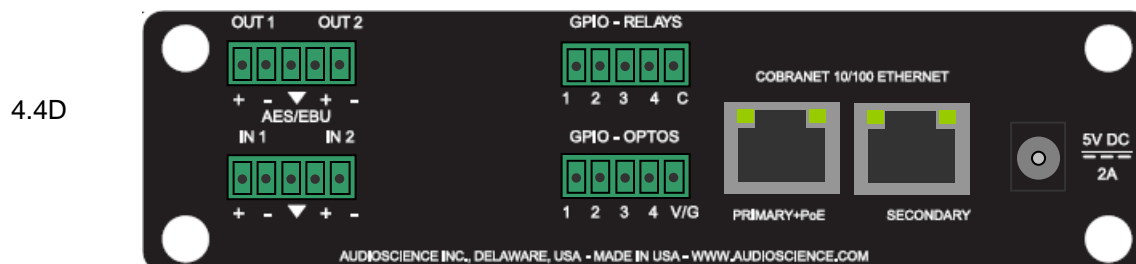
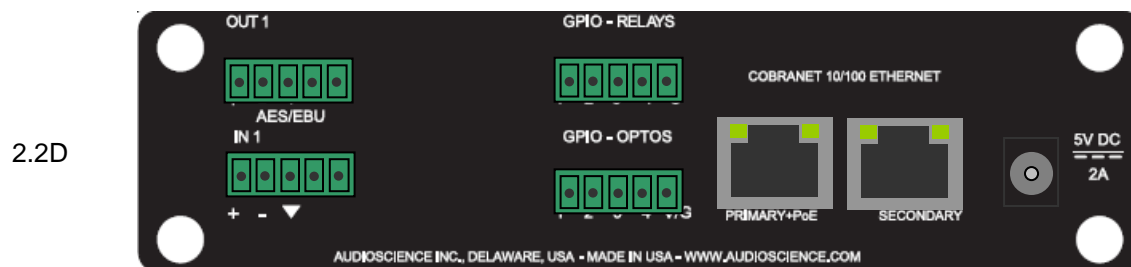
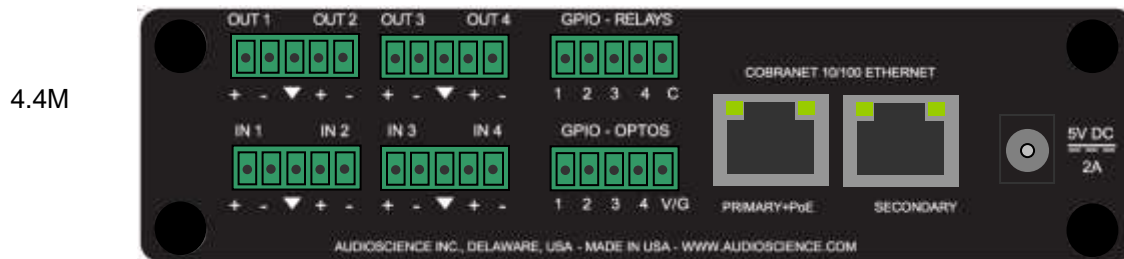

12.2.1 OUT 1..4

2.2M & 4.4M: These are the balanced analog outputs. The middle pin of the 5pin terminal block is Ground
 2.2D & 4.4D: These are the AES/EBU outputs. The middle pin of the 5pin terminal block is Ground

12.2.2 IN 1..4

2.2M & 4.4M: These are the balanced analog inputs. The middle pin of the 5pin terminal block is Ground.
 2.2D & 4.4D: These are the AES/EBU inputs. The middle pin of the 5pin terminal block is Ground.

12.2.3 GPIO – RELAYS

These are the four GPIO Output relays

12.2.4 GPIO-OPTOS

These are four GPIO opto-isolated inputs. V/G is used to power the optos from either internal or external power.

12.2.5 RJ45 – PRIMARY+PoE

The primary CobraNet network connection. Also provides PoE power input.

12.2.6 RJ45 – SECONDARY

The secondary CobraNet network connection, when using a redundant CobraNet network. Does not provide PoE power input.

12.2.7 5V DC Jack

Provides input for an external +5V @ 2A power supply (supplied with the unit)

13 HARDWARE INSTALLATION

13.1 Mounting

13.1.1 Flange Mounting

The Hono Mini CobraNet interface mounts using the flanges on the side of the unit

13.1.2 Rack Mounting

The Hono Mini CobraNet interface can be rack mounted using the optional rackmount bracket (p/n ENC2305). This bracket can mount up to three Hono Minis.



13.2 Ethernet Connection

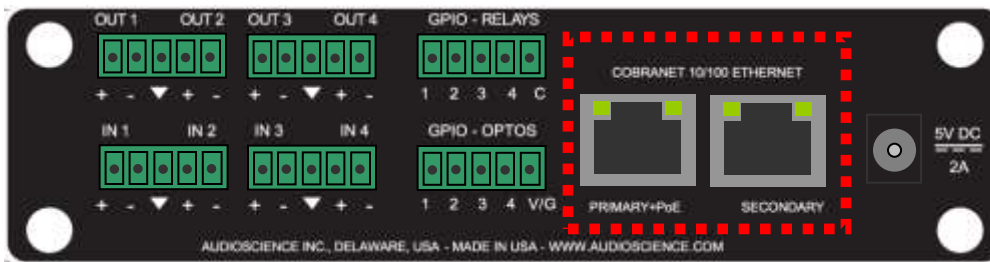

There are two RJ-45 Ethernet jacks on the rear of the unit. If a redundant CobraNet network is not being used then plug a network cable into the PRIMARY jack. If a redundant network is being used then plug a second network cable into the SECONDARY jack. (See http://cobranet.info/support/design/switched_networks for information on redundant networks.)

A CAT-5 or better (CAT-5e, CAT-6 etc) network cable is required for 100baseT Ethernet operation. The cable length between the Hono Mini interface and a network switch should not exceed 100 meters (328 feet)

13.2.1 PoE Power

If your network provides power-over-ethernet (PoE) capability, then you can use it to power the Hono Mini.

NOTE: Only the primary CobraNet port has PoE ability

13.2.2 External +5V Power

The Hono Mini CobraNet interface can use external +5V power, supplied using a 2.5mm DC plug. This power takes priority over the PoE power if both are supplied at the same time

14 OPERATION

14.1 Power up sequence

This section describes the power up sequence.

14.1.1 Power

Apply power to the unit by either using a PoE enabled network on the primary RJ45 jack or by plugging in the external +5V power supply. You may apply both at the same time, but the external power supply will take priority.

14.1.2 Firmware images

The Hono Mini CobraNet interface boots from a firmware image stored in flash memory. There are two independent firmware images stored in every unit. The two images are named "Factory" and "Update". The "Factory" image is a reference image that is in place should a "bad" image be downloaded to the device. The "Update" image is the image that can be updated in the field if required.

14.1.3 Firmware loading sequence

When first powered up, each Hono Mini CobraNet interface performs the following sequence:

1. Checks for a valid "Update" firmware image.
2. Loads the Update image and starts running it.
3. Loads any control settings that may have been stored to flash.

In the case where the "Update" image is determined to be corrupt, the Factory image is loaded. This situation is noted by the STATUS LED being lit as **orange**.

14.1.4 Loading the factory firmware image

The Hono Mini CobraNet interface can be forced to load the factory firmware image by depressing the CLEAR SETTINGS button on front panel as power is applied to the device. Keep the button depressed while power is applied. The STATUS LED will be lit as **orange**

14.2 Resetting the Configuration to Default Settings

14.2.1 Resetting Audio Control Settings

Resets all mixer volumes, signal processing analog levels back to default settings.

The Hono Mini CobraNet interface stores audio control settings in flash memory so that they may be restored upon power up. To restore all control settings to factory defaults perform the following steps:

1. Enter MENU mode by pressing the CLEAR SETTINGS button for 1 to 3 seconds, until the meter LEDs all blink **green**.
2. Press the button until the 3rd LED from the left is blinking.
3. Press the button for between 1-3 seconds until the LED stops blinking.
4. The units control settings will now be set to their default settings

14.2.2 Resetting Static IP Address

If you have configured the unit for a static IP address, you can reset it back to a dynamically assigned IP address using the following steps:

1. Enter MENU mode by pressing the CLEAR SETTINGS button for 1 to 3 seconds, until the meter LEDs all blink **green**.
2. Press the button until the 2nd LED from the left is blinking.
3. Press the button for between 1-3 seconds until the LED stops blinking.
4. The units IP LED will now turn from **Orange** to flashing **Orange** until it has acquired a new dynamic IP address.

14.2.3 Resetting CobraNet Persistence

Resets all CobraNet Tx and Rx bundles to 0. If you somehow get your Hono Mini CobraNet interface into a state where you cannot communicate with it, the CobraNet persistence variable can be reset from the front panel of the unit. This may allow communication with the Hono Mini CobraNet interface

- Enter MENU mode by pressing the CLEAR SETTINGS button for 1 to 3 seconds, until the meter LEDs all blink **green**.
- Press the button until the 1st LED from the left is blinking.
- Press the button for between 1-3 seconds until the LED stops blinking.
- The units control settings will now be set to their default settings

14.3 Network Interface

Hono Mini CobraNet interface audio settings are configured over the network via UDP messages using port 44600. The unit's CobraNet networking settings are set using SNMP messaging. Both of these protocols require an IP address to be assigned to the unit.

14.3.1 Network Mask Assignment

The networking stack used for UDP messaging on each Hono Mini CobraNet interface uses the following rules to automatically assign a NetMask:

Class A subnet: 1.0.0.0 - 127.0.0.0, Private allocation range: 10.0.0.0 - 10.255.255.255
 NetMask : 255.0.0.0

Class B subnet: 128.0.0.0 - 191.255.0.0, Private allocation range: 172.16.0.0 - 172.31.255.255

NetMask : 255.255.0.0

otherwise

NetMask: 0.0.0.0

15 CONFIGURATION

15.1 ASIControl Configuration

ASIControl is a Windows application that is installed along with the AudioScience drivers. If you are using an AudioScience CobraNet adapter or an AudioScience non-CobraNet audio adapter in the PC, choose the Wave, WDM, or Combo driver to download and install (the driver type to install will be dependant upon the application used with the AudioScience adapter; consult the manufacturer of the application). If you do not have an AudioScience adapter installed in the PC, simply download the Wave driver.

Run the driver .exe to install the driver components and be sure to select the second install option: "Standard PCI + Network Driver".

After driver installation, ASIControl can be run from either the desktop icon or from Start → All Programs → AudioScience → ASIControl.

If there is more than one NIC in the PC, upon startup, ASIControl will first prompt the user for which network interface to use to communicate with CobraNet devices. Next, to invoke the CobraNet Object Tools COM object to assign IP addresses to any CobraNet devices that do not currently have valid IP addresses, select Options→Configure CobraNet IP address range and fill in the range. (See the CobraNet section for further information.) Hono Mini CobraNet interface communication with the host is via UDP messaging using port 44600.

To preserve control changes made to the Hono Mini CobraNet interface, ASIControl must be shut down. This will save control settings to the unit's flash memory, allowing the settings to be restored after a power cycle.

15.1.1 ASIControl Layout

List of CobraNet devices discovered on the network. Highlighted device is shown in the topology pane.

Topology pane showing the inputs and outputs of the selected adapter.

The node 1 Microphone 1 has been selected by left clicking with the mouse. Its controls show up in the node

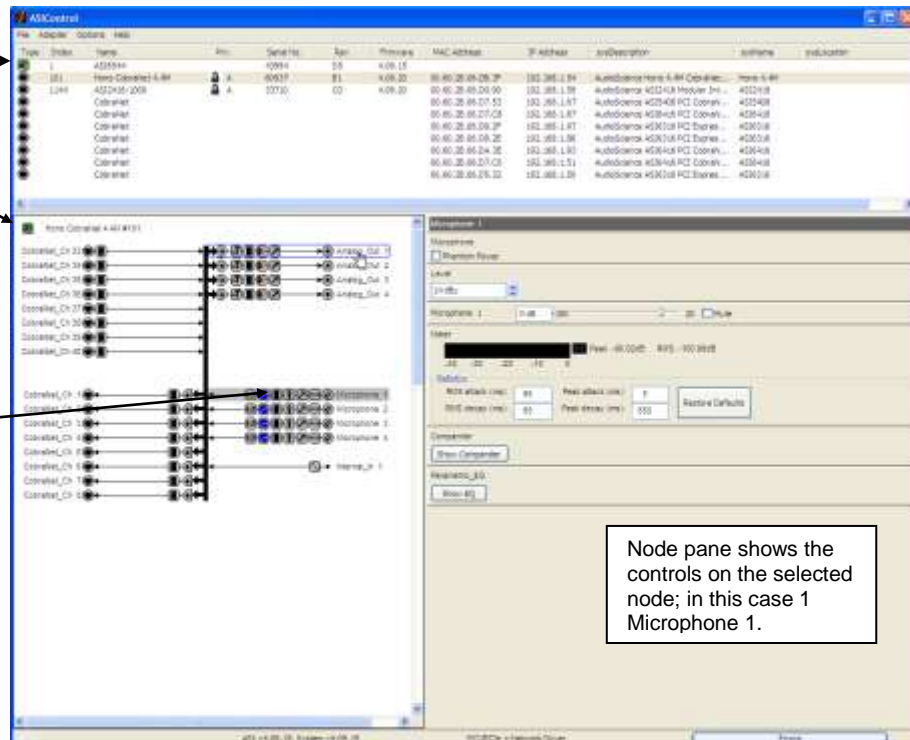

Node pane shows the controls on the selected node; in this case 1 Microphone 1.

Figure 2. ASIControl layout

15.1.2 About

This control displays information about the installed Hono CobraNet.

15.1.2.1 Interface

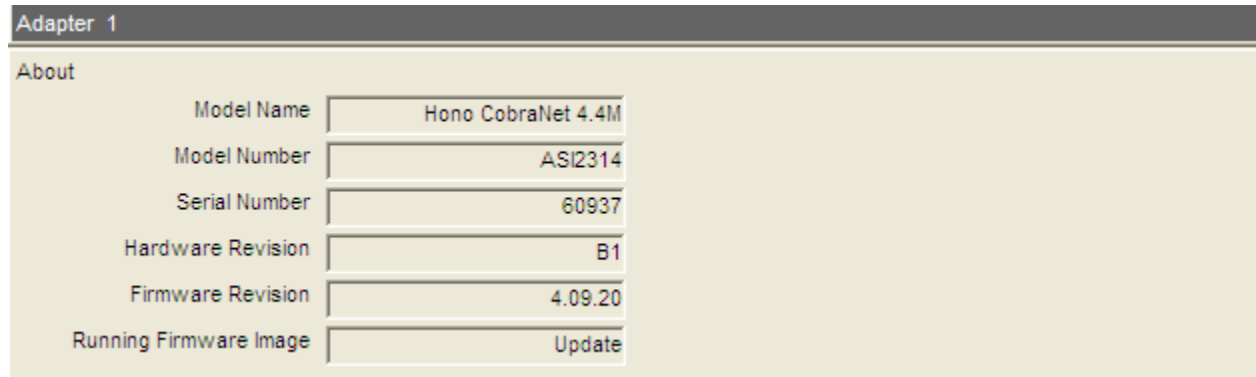

Figure 3. Adapter About information seen in right side of ASIControl.

Model Name:

The model name is displayed here.

Model Number:

The model number is displayed here.

Serial Number:

The serial number is displayed here.

Hardware Revision:

This lists the hardware revision.

Firmware Revision:

The firmware version is displayed; usually the same as the driver version installed.

15.1.3 Status

This control displays information on various dynamic parameters .

15.1.3.1 Interface

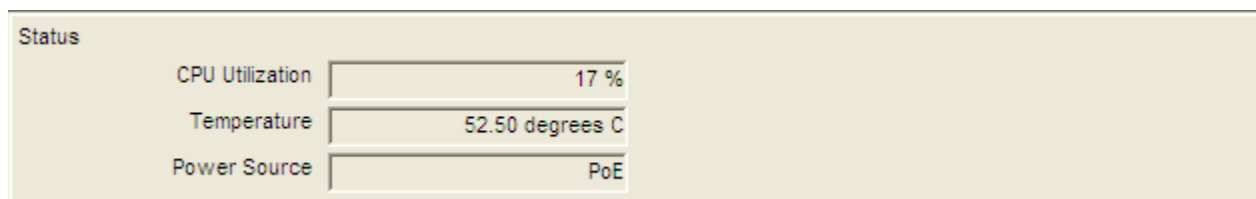

Figure 4. The Status user interface

CPU Utilization:

This shows the loading of the adapter's CPU load in percent.

Temperature:

The internal temperature in degrees C is shown here.

Power Source:

PoE indicates the unit is running off Power-over-Ethernet. External indicates it is using the external +5V adapter.

15.1.4 Level

The levels in dBu for the adapter's line_outs and line_ins can be adjusted here.

In the example below, the Line_Out 1 node in the topology view of ASiControl has been selected. Its Level will show up on the right side of ASiControl. The same is done for a Line_In to see its Level.

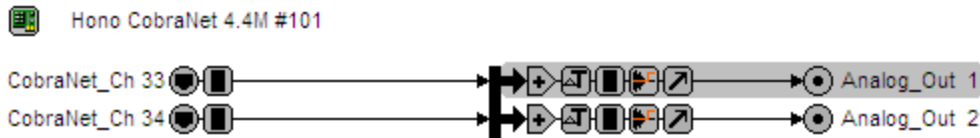



Figure 5. Using ASiControl to select Analog_Out 1

15.1.4.1 Interface



Figure 6. Level displayed by ASiControl for Line_Out 1

Level:

The line out level can be adjusted by clicking the  arrows or by typing values in to set the appropriate level. Consult the specification section of this datasheet for the range of supported levels.

15.1.4.2 Developer

15.1.4.2.1 Windows APIs

Wave/Mixer – Analog levels are controlled using `mixerSetControlDetails()` on a control of type signed and with the name Level/Trim.

HPI – Analog levels are controlled using the [HPI_LevelSet\(\)](#) API.

ASX – Analog level are controlled using the [ASX_Level_Set\(\)](#) API.

DirectSound – TBD.

15.1.4.2.2 Linux APIs

HPI – Analog levels are controlled using the [HPI_LevelSet\(\)](#) API.

ASX – Analog level are controlled using the [ASX_Level_Set\(\)](#) API.

ALSA – TBD.

15.1.5 Meter

Meters in ASiControl are located on audio nodes and display the audio level as the audio signal passes through the node. Most AudioScience devices return both RMS and peak level readings and ASiControl displays both simultaneously.

15.1.5.1 Interface

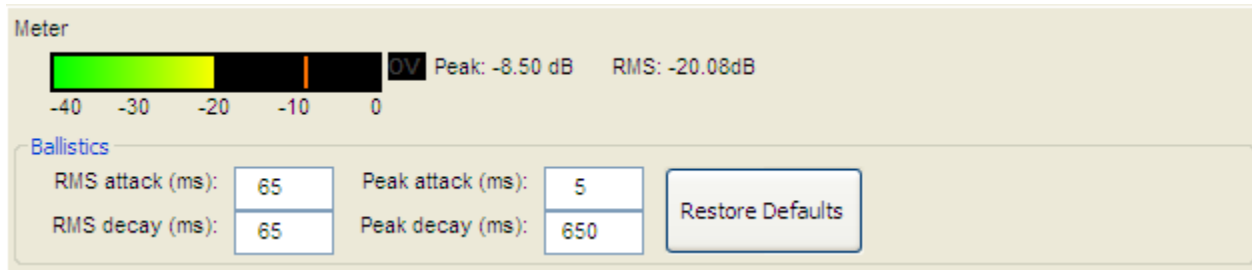

Figure 7. A stereo peak meter display; RMS is green and peak is yellow

To the right of the peak meter is the absolute readings in dBFS. These can be useful when testing input tones of a specific known level.

15.1.5.2 Developer

15.1.5.2.1 Windows APIs

Wave/Mixer – Meters are read using `mixerGetControlDetails()` on a control of type signed and with type “Peak” the name “Peak Meter”. A minimum value is 0 and maximum is 32767. The interface returns the peak readings only, not the RSM level. It conforms to expected Windows functionality.

HPI – Meters are read using the [HPI_Meterxxx\(\)](#) API.

ASX – Meters are read using the [ASX_Meter_xxx\(\)](#) API.

DirectSound – TBD.

15.1.5.2.2 Linux APIs

HPI – Meters are read using the [HPI_Meterxxx\(\)](#) API.

ASX – Meters are read using the [ASX_Meter_xxx\(\)](#) API.

ALSA – TBD.

15.1.6 AES/EBU I/O

The Hono CobraNet 2.2D and 4.4D have AES/EBU I/O.

- Hono CobraNet 2.2D – 1 AES/EBU output and 1 AES/EBU input (2 channel I/O)
- Hono CobraNet 4.4D – 2 AES/EBU outputs and 2 AES/EBU inputs (4 channel I/O)

15.1.6.1 AES/EBU Inputs

Each AES/EBU input has a sample rate converter (SRC) on it and so may have a sample rate that is asynchronous to the rest of the system. Valid sample rates are 32, 44.1, 48, 64, 88.2 and 96kHz.

15.1.6.2 AES/EBU Outputs

The AES/EBU outputs are clocked at 48kHz, the same rate as the CobraNet interface and cannot be changed.

15.1.7 Input and Output Volume Adjustment

All outputs from the Hono Mini CobraNet interface have volume adjustments in their path that support a range of –100 to +20 dB. The nodes that support this are CobraNet_Ch 1-8, Analog_Out 1-4 and AES/EBU_Out 1-2.

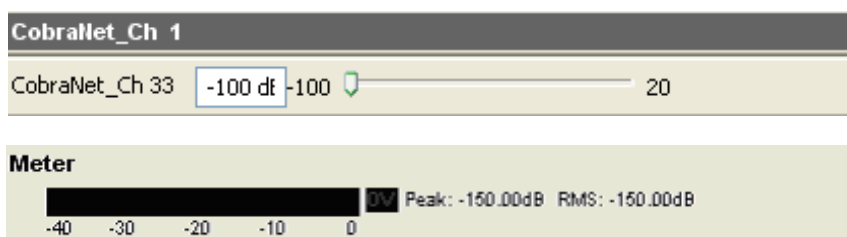

Clicking on CobraNet_Ch 1 in the topology pane of ASIControl will show a list of volumes in the node view pane. Below is an image of the first volume shown in the node pane. The meter is found after the list of volumes (the Hono Mini CobraNet interface incorporates AudioScience’s ‘anything to anywhere’) mixing).

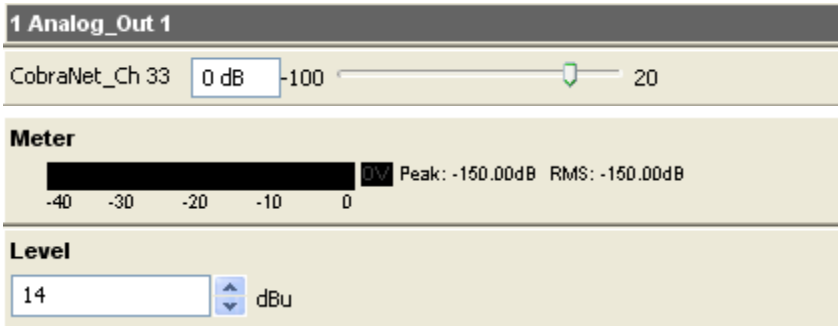

Clicking on Analog_Out 1 in the topology pane of ASIControl will show a list of volumes in the node view pane. Below is an image of the first volume shown in the node pane. The meter and level is found after the list of volumes (the Hono Mini CobraNet interface incorporates AudioScience's 'anything to anywhere' mixing).

Figure 8. ASIControl node displays with volumes

The volumes are self-explanatory. Just drag the sliders. All lineouts also have an audio path (with volume) from the corresponding line in. This can be use useful in verifying the correct operation of the audio modules without having to send the audio across a CobraNet network.

15.1.8 Audio Delay

The audio delay block supports user programmable delay per audio output. By default, each output has a maximum of approximately 80 milliseconds of delay assigned to it. If a larger delay is required, more delay storage can be assigned from the global unallocated pool of storage. The maximum delay is 10 seconds.

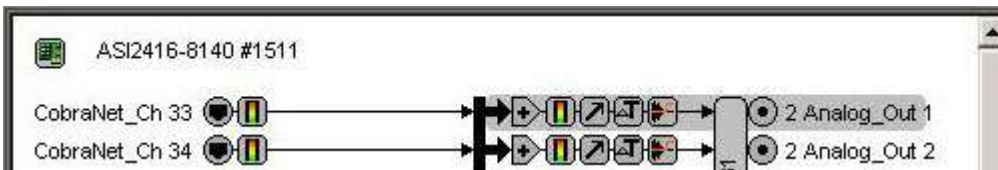

Figure 9 Using ASIControl to select Analog_Out 1

15.1.8.1 Interface

	ms	metres	feet
Delay	25.000	8.582	28.155
Maximum Delay	85.333	29.291	96.100
Unallocated Delay	31317.334	10749.988	35268.992

Figure 10 Audio Delay displayed in right pane of ASIControl for Line_Out 1

Delay:

The audio delay is specified in MS (milliseconds), metres, and feet in the user interface. It can be adjusted by typing in new values.

15.1.8.2 Developer

15.1.8.2.1 Windows APIs

HPI – The Audio Delay is a block control. See [functions](#) then Mixer, Blocks, Audio Delay.

ASX –TBD.

15.1.8.2.2 Linux APIs

HPI – The Audio Delay is a block control. See [functions](#) then Mixer, Blocks, Audio Delay.

ASX – TBD

ALSA – TBD.

15.1.9 Signal Generator

In the topology pane of ASiControl, click on Internal_In 1

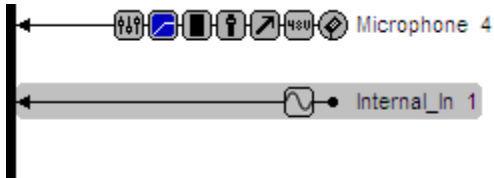

Figure 11. Internal node as seen in ASiControl

to see the Signal Generator information in the node pane.

15.1.9.1 Interface

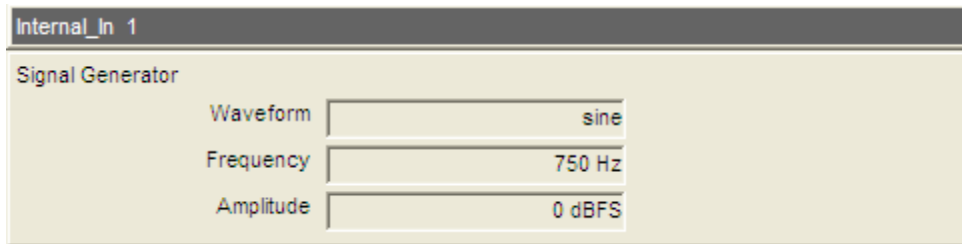

Figure 12. Signal Generator User Interface as seen in ASiControl

Waveform:

The signal generator waveform type is fixed as a Sinewave.

Frequency:

The frequency is fixed at 750Hz.

Amplitude:

The amplitude is fixed at 0dBFS.

15.2 Mic/Line input configuration

For each mic/line input, the following can be configured

- Phantom power
- Input Level (Sensitivity)
- Parametric Equalizer
- Compressor/Limiter

Here are the controls as viewed in ASIControl's node pane (its right pane):

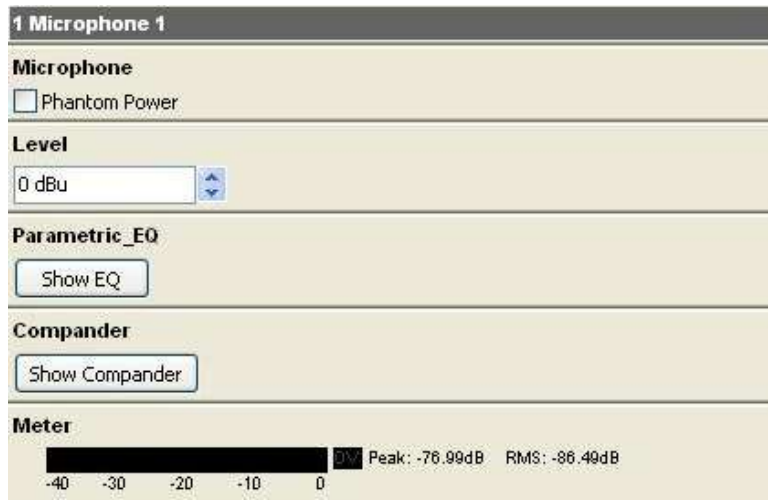

Further information on each control follows.

15.2.1 Phantom Power



The Phantom power (48v) can be set on and off independently for each channel by checking or unchecking the checkbox.

Note: Phantom power cannot be turned on and will be disabled if the Level is higher than -9dBu.

15.2.2 Input Level



The input level can be set between -60 and +26dBu in 1dB increments by either using the up/down arrows to the right of the Level textbox or by clicking in the Level textbox, typing in a particular number, and then hitting the <Tab> key on the keyboard.

ALSA – TBD

15.2.3 Parametric Equalizer

The AudioScience parametric equalizer is a 5 band parametric equalizer. It is located on the Line_In and AES/EBU_In nodes and may be used on both the Line In, AES/EBU In, and Microphone signals. Each of the equalizers 5 bands may be individually programmed with filter type (Bypass, Lowshelf, Highshelf, Equalizer, Lowpass, Highpass, Bandpass, and Bandstop), Q (sharpness), and center frequency.

10.2.3.1 Interface

The Parametric Equalizer is accessed from the ASIControl by clicking on either a Line_In or an AES/EBU_In in the left side of ASIControl then clicking on the “Show EQ” button on the right side of ASIControl.

Parametric_EQ



The Parametric EQ opens, shown below.

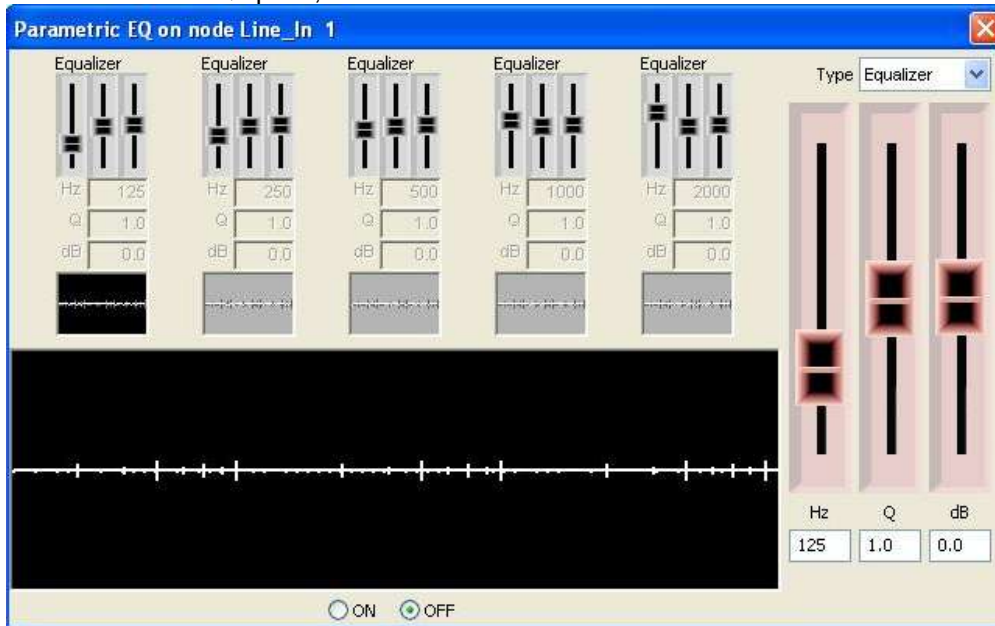

Figure 13 The Parametric EQ as seen in ASIControl

The EQ window contains controls for setting the filter parameters of each of the 5 bands, with a graph showing the combined frequency response of the 5 bands.

Clicking on one of the bands highlights it by changing its small graph display black, as shown on the left band in the image above. Select the type of graph you want from the Type selection box in the upper right corner, and adjust levels by sliding the large sliders on the right. Click on the next equalizer and change its parameters as needed.

At the bottom of the ASI Parametric EQ pop up, click on the On radio button to activate it.

Each filter band has the following parameters:

Filter Type – The shape of the filter. Supported filter types are:

- Bypass – filter is turned off
- Low Shelf – EQ low shelf
- High Shelf – EQ high shelf
- Equalizer – EQ band (default)
- Low Pass – Standard low pass
- High Pass – Standard high pass
- Band Pass – Standard band pass
- Band Stop – Standard band stop/notch

Filter Hz (Freq) – The center frequency of the filter.

Filter Q – The sharpness of the filter. The higher the Q, the more selective the filter is.

Filter dB (Gain) – The gain of the filter at the center frequency.

10.2.3.2 Developer

10.2.3.3 Windows APIs

Wave – Use the equalizer mixer control – see “[AudioScience WavX Specification](#)”

HPI – Use the HPI_ParametricEQ_XXXX APIs – see “[AudioScience HPI Specification](#)”

ASX – TBD

DirectSound – TBD

10.2.3.4 Linux APIs

HPI – TBD

ASX – TBD

ALSA – TBD

15.2.4 Compressor/Limiter

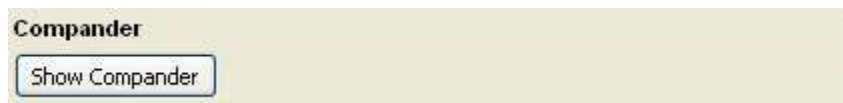

Clicking on the Show Compander button will bring up the ASI Compander pop-up, shown below.

Adjust the sliders as needed, and select the On radio button to activate the ASI Compander.

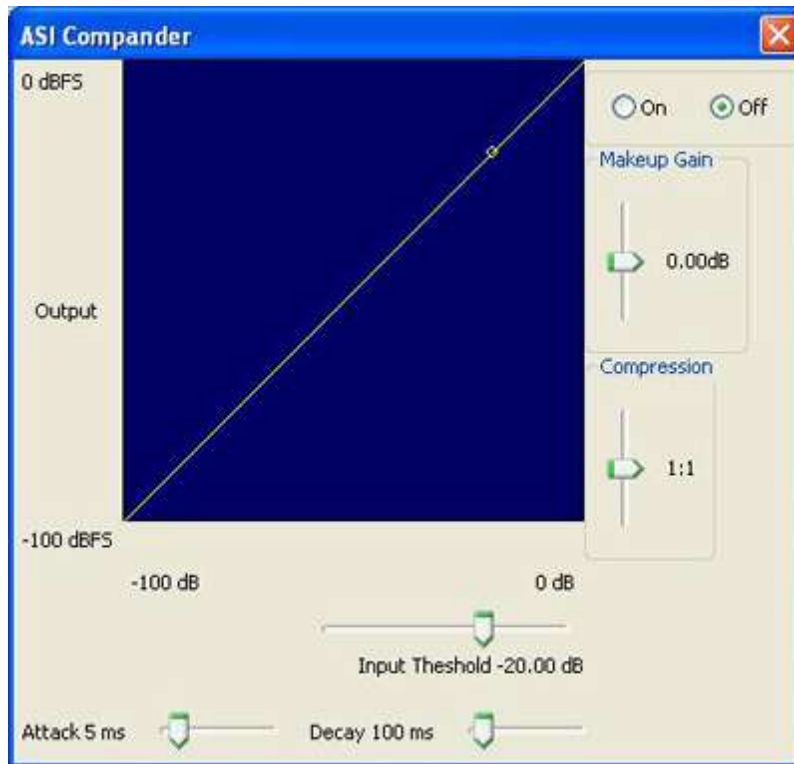

15.3 Access control using passwords

Beginning with driver 4.10.00, some AudioScience adapters support password protected access to adapter controls. In ASIControl, an adapter that supports passwords shows a padlock in its adapter information line of the adapter list window. For example see

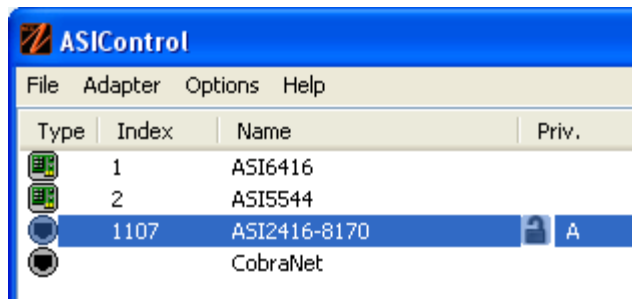

By default, if a password has not been set, the adapter operates as if there is no active password. Any user has complete access to all the device functionality.

The access control system supports 3 different “user” login levels. Their levels their associated privileges are outlined in the following table.

Username	Controls	Scripting	Configuration Save/restore	Passwords
Admin	Read/write	Read/write	Read/write	Write
User	Read	No access	No access	No access
Guest	Read	No access	No access	No access

Password information is stored on the adapter itself, not the host computer, so if a different computer is used to control the adapter, the same passwords should be used.

15.3.1.1 Login in states

15.3.1.1.1 Admin

This is the default state if no passwords have been set on the device. Or, the user has logged in using the Administrator password. This is indicated in the ASIControl as:



15.3.1.1.2 User

The user successfully has logged in using the User password. This is indicated in the ASIControl as:



15.3.1.1.3 Guest

If passwords have been set, but the user has not logged on, the Guest privilege level is invoked. This is indicated in the ASIControl as:



15.3.1.2 Setting passwords

Right click on the highlighted adapter and follow the menu tree to

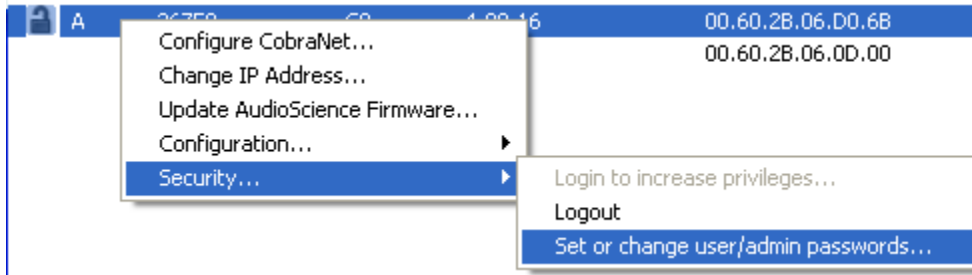

the “Set...” option. The following dialog will show.



Select User or Admin from the first combo box and enter the new password in the two password fields.

Upon setting a password for the first time on a device that has never had a password before, Admin rights are assumed to be in place for the current user, so after setting the password the user should logout if they wish the adapter to be secured.

Note that on an PCI or PCIe adapter that has password support, the user should not power down or restart the PC within 30 seconds of changing the passwords. In other words, permanent storage of the updated passwords settings can take up to 30 seconds.

15.3.1.3 Logging in

Right click on the adapter in the list to login and increase user rights.

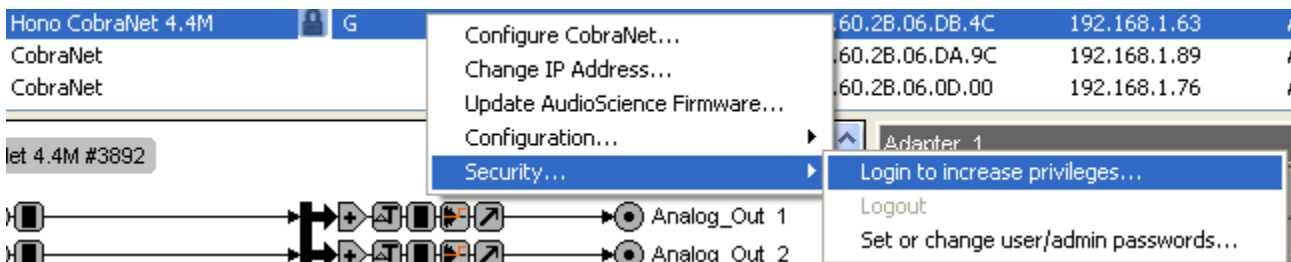

and enter the password for the access privilege level that you wish to use.

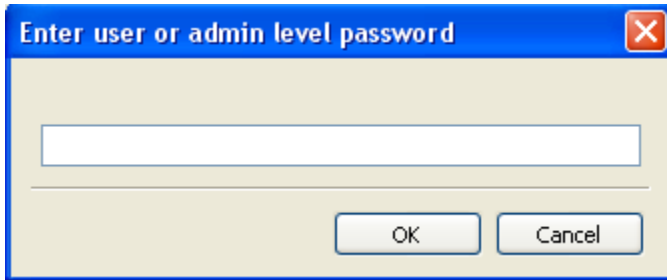

15.3.1.4 Logging out

After completing privileged operations, logout is performed by right clicking on the adapter and selecting the logout option.

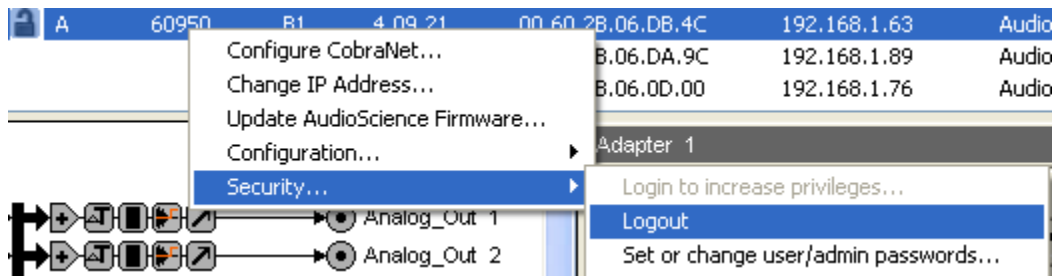

15.4 GPIO

General Purpose Input/Output (GPIO)

15.4.1 Outputs

The Hono Mini provides four GPIO outputs (1...4).

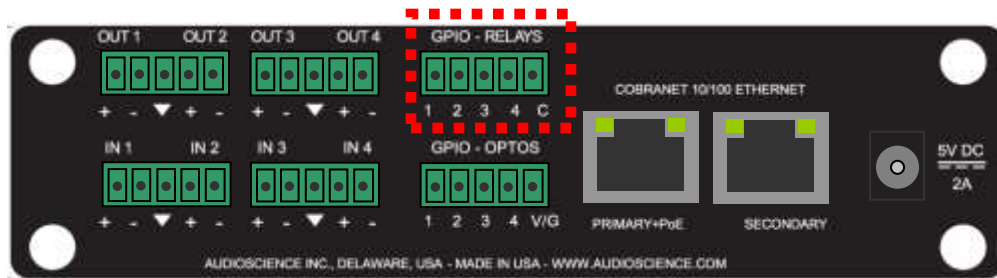

Each outputs consists of a normally open relay with one side connected to a common pin (C). The current through each relay should be limited to 500mA.

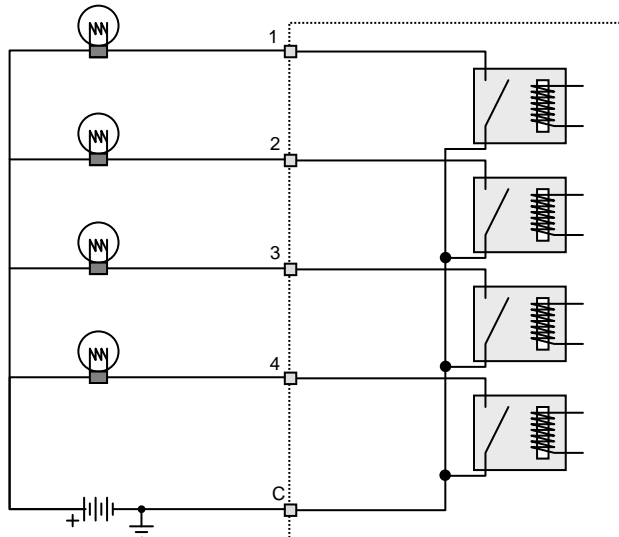

15.4.2 Inputs

The Hono Mini GPIO provides four opto-isolated inputs (1...4).

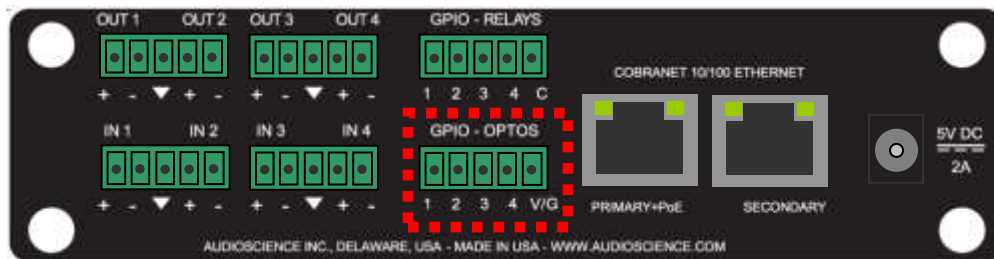

The voltage powering the LED in the opto-isolator may either be supplied from an external source through the V/G pin or may be powered from the Hono Mini's internal +5V supply. The opto-isolator voltage is software selectable using ASIControl and the setting is stored in the units non-volatile memory,

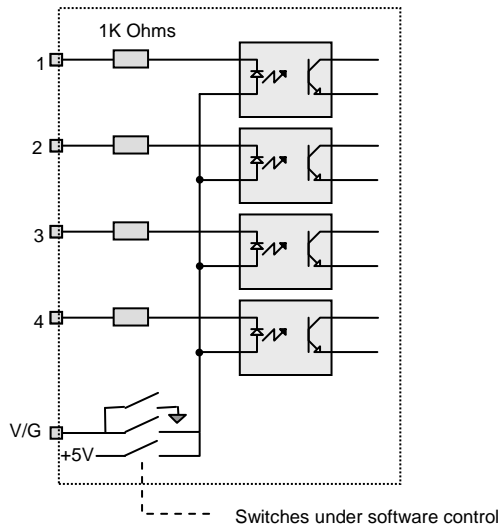

15.4.2.1 V/G Pin Function - Ground

When using the internal voltage source, the V/G pin becomes ground. Connecting an opto-isolator input to V/G will turn it on. Approximately 5mA is needed to fully turn on each opto-isolator. When using the internal +5V power source then the internal 1K ohm current limiting resistors are all that is needed.

NOTE: In this mode the opto-isolators are not being used as isolators.

The following diagram shows the connections needed if using this mode.

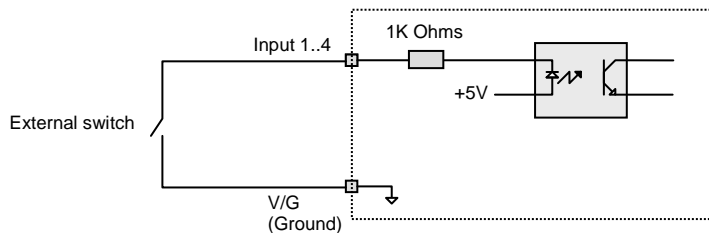

15.4.2.2 V/G Pin Function – Power Input

When using an external power source for the opto-isolators, the V/G pin becomes an input for the external voltage. In this mode, a maximum external voltage of +14V can be used, so as not to damage the opto-isolators.

Use the following diagram as a guide to connections:

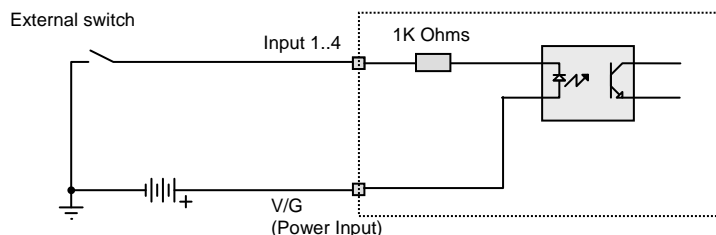

15.5 CobraNet Configuration

ASiControl can be used to configure both AudioScience CobraNet devices and third party CobraNet devices, via its CobraNet Configuration dialog box. This dialog box can be used to configure CobraNet devices and assign names, locations, bundle numbers, channel assignments, etc. Third party applications such as CobraNet Discovery can also be used to configure AudioScience CobraNet devices.

Below lists how to set up AudioScience's software so ASiControl may be used to configure CobraNet.

NOTE: Under some Windows operating systems, ASiControl must be run as administrator in order to see all networked CobraNet devices. In Windows 7 this is done by right clicking on the ASiControl shortcut on the desktop and selecting "Run as administrator."

NOTE: Some antivirus programs and/or firewalls can prevent ASiControl from showing all CobraNet devices on a CobraNet network. If all CobraNet devices are not showing in the top pane of ASiControl, please check settings and/or turn off any antivirus programs or firewalls that may be running on the PC.

15.5.1 Setting Up AudioScience Software to Configure CobraNet

15.5.1.1 Setting Up AudioScience Software Using a PC

To configure AudioScience Hono Mini CobraNet devices using ASiControl, the following must be in place: the AudioScience network driver must be installed on a PC (this PC will run ASiControl), the networked adapters option must be selected in ASiControl, the Hono Mini CobraNet device must be connected to the CobraNet network via an Ethernet cable, and the PC that is running ASiControl must also be connected to the same CobraNet network. The steps below describe how to do this.

15.5.1.1.1 Install the Network Driver

When an AudioScience driver install EXE is run, three choices are made available as shown in the image below. Select "Install Standard + Network Audio Driver" when installing AudioScience CobraNet products, then run the driver install EXE as usual.

- Install Standard PCI/PCIe Driver.
- Install Standard + Network Audio Driver.
- Remove all driver components.

15.5.1.1.2 Select Networked Adapters in ASIControl

In ASIControl, go to the menu item Options, then select Configure adapter interface, as shown below.

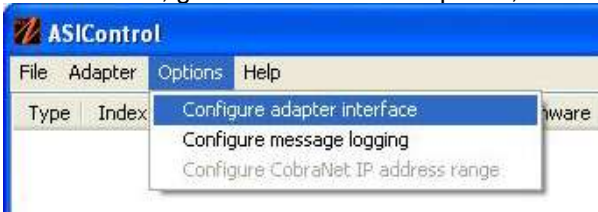

Since ASIControl is used for both AudioScience’s non-CobraNet adapters and CobraNet adapters, the correct interface must be selected when using ASIControl for CobraNet configuration. Click on menu item Options, then Configure adapter interface. The Interface Selection dialog box opens; the default selection is “Local PCI(e) adapters. Select ‘Local PCI(e) + Networked adapters.’ then click OK.



ASIControl will restart, looking for all CobraNet devices on the network, assigning IP addresses where needed, and showing CobraNet devices on the network in its top pane.

15.5.1.1.3 Connect CobraNet Device to the Network

Plug one end of an Ethernet cable into the back of the AudioScience CobraNet device. Plug the other end into the CobraNet or test network.

15.5.1.2 Setting Up AudioScience Software Using a Laptop

The Hono Mini CobraNet interface can be configured using a laptop and an Ethernet crossover cable. Follow the steps above to install the AudioScience network driver must be installed on the laptop, then connect the laptop to the Hono Mini CobraNet device using an Ethernet crossover cable. The laptop’s network adapter must have a static IP address.

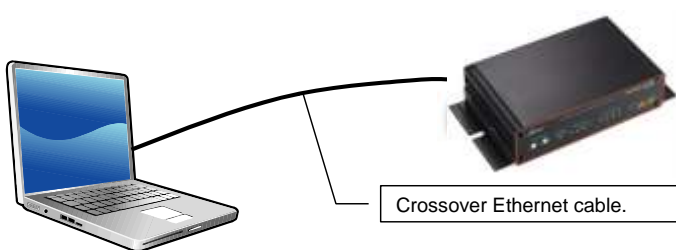
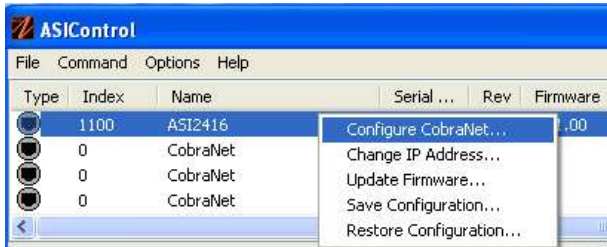

Figure 14. Laptop to Hono Mini CobraNet interface connection

15.5.2 Configuring CobraNet Using ASiControl

The CobraNet Configuration dialog box is accessed via ASiControl, which is installed when the driver EXE is run. Double click on the ASiControl icon on the desktop, then in the top section right click on the CobraNet device and select Configure CobraNet... (see further for information on the other selections available):



The CobraNet Configuration dialog box opens:

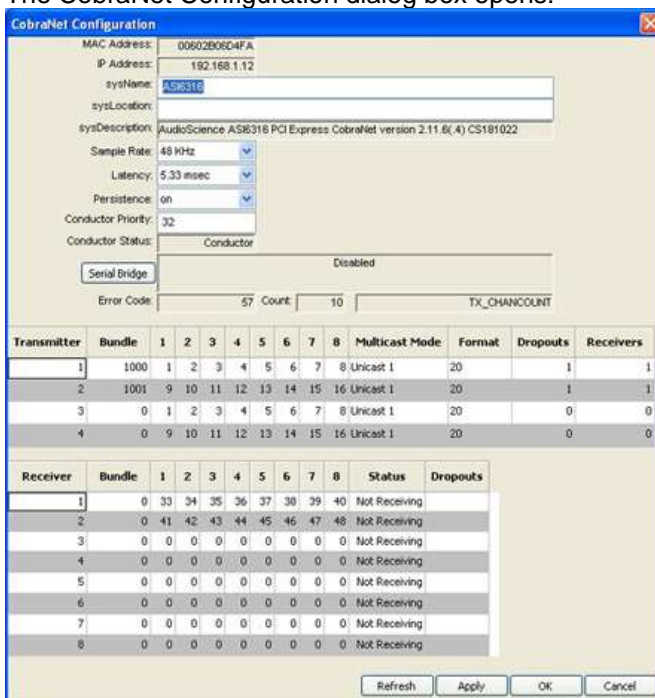

Figure 15. ASiControl's Configure CobraNet

15.5.2.1 CobraNet Configuration Dialog Box

There are three main sections of the dialog box: the top shows the **configuration section** of the CobraNet device, the **transmitter section** is in the middle, and the **receiver section** is at the bottom. There are also four user control buttons on the bottom right.

15.5.2.1.1 Configuration Section

MAC Address:

Read only; displays the MAC address of the CobraNet device.

IP Address:

Read only, displays the assigned IP address of the CobraNet device.

sysName:

Editable; a meaningful name can be given to a CobraNet device here. The default setting will be the name of the CobraNet device; for example "Hono Mini CobraNet 8.8M."

sysLocation:

Editable; a physical location can be listed here for ease of reference. The default setting is blank.

sysDescription:

Read only; lists the type of CobraNet interface. The default setting will be the full name a CobraNet version number of the CobraNet device, for example "AudioScience Hono Mini CobraNet 8.8M version 2.11.4(.3) CS181022."

Sample Rate:

Default setting is 48kHz ; a CobraNet device must run at one sample rate only. Two CobraNet devices on the same network can each operate at a different sample rate.

Latency:

Choose between 1.33, 2.67, or 5.33 ms (default setting).

Persistence:

Default is 'off.'). In most real world deployments the persistence bit should be set to on so that the Hono Mini CobraNet device will remember its CobraNet settings and IP address in the event of a power cycle. If the persistence bit is left off, bundle numbers, sysName, and sysLocation will be set back to default values on power cycle.

Conductor Priority:

Editable; set a low number to ensure the CobraNet device will always be a Performer (it will never be a Conductor) or set it to a high number to ensure it will always be a Conductor (it will never be a Performer). The following are Cirrus numbering conventions:

- 0 = never conductor
- 32 = normal conductor priority (the CobraNet device will either be the Conductor or the Performer)
- 128 = high conductor priority (the CobraNet device will be the Conductor)

Conductor Status:

Read only; displays if the CobraNet device is a Conductor or Performer.

Error Code:

Displays CobraNet-specific error information using Cirrus' error numbering conventions.

Count:

Displays the number of errors that have occurred on the device. Some errors result from normal operation; disconnecting cables, rerouting, etc. The text field to the right of Count displays the Cirrus-related text.

15.5.2.1.2 Transmitter Section

The Hono Mini CobraNet devices will have the following transmitter defaults:

Transmitter	Bundle	Ch 1 map	Ch 2 map	Ch 3 map	Ch 4 map	Ch 5 map	Ch 6 map	Ch 7 map	Ch 8 map	Format	Count	UniCast Mode
TX1	0	1	2	3	4	5	6	7	8	20 bits	8	Never
TX2	0	9	10	11	12	14	14	15	16	20 bits	8	Never
TX3	0	1	2	3	4	5	6	7	8	20 bits	8	Never
TX4	0	9	10	11	12	14	14	15	16	20 bits	8	Never

Information on the Transmitter section as seen in ASIControl's Configure CobraNet dialog box:

Transmitter:

Sends an audio bundle, made up of up to 8 audio channels, to a CobraNet receiver on the network.

Bundle:

The basic CobraNet audio routing component, can have 0 to 8 audio channels. Assign specific bundle numbers here.

Bundle numbers can be 0 and 1 – 65535

- 0 for turning transmitter off or for silence
- 1-255 for multicast
- 256-65279 for unicast
- 65280-65535 for private

1-8 Audio Channels:

The number of mapped channels from mixer to transmitter. Channels 0 (inactive) and 1-32 can be assigned. A 0 mapping of end channels 'shortens' the bundle; a mapping of 0 in the middle of mapping denotes silence.

Multicast Mode:

Double click to change setting in the dropdown list; use the following table to determine what setting to select:

Settings	Number of Receivers <= N	Number of Receivers > N
Multicast Bundle # < 256	Multicast	Multicast
Always	Multicast	Multicast
Unicast N	Unicast	Unicast if Receiver = 1-N Fail if Receiver > N
Multicast Over N	Unicast	Multicast

Information on the Receiver section as seen in ASIControl's Configure CobraNet dialog box:

Format:

Double click to change the audio sample format to 16, 20, or 24 bits.

Dropouts:

The number of times the channel transmission has been interrupted. Interruptions can be caused by loss of transmit permission from conductor (i.e. conflict with another transmitter set to the same bundle number) or by changes to txBundle.

Receivers:

The number of receivers requesting this bundle.

15.5.2.1.3 Receiver Section

The Hono Mini CobraNet devices will have the following receiver defaults:

Receiver	Bundle	Ch 1 map	Ch 2 map	Ch 3 map	Ch 4 map	Ch 5 map	Ch 6 map	Ch 7 map	Ch 8 map	Format
RX1	0	33	34	35	36	37	38	39	40	undefined
RX2	0	41	42	43	44	45	46	47	48	undefined
RX3	0	0	0	0	0	0	0	0	0	undefined
RX4	0	0	0	0	0	0	0	0	0	undefined
RX5	0	0	0	0	0	0	0	0	0	undefined
RX6	0	0	0	0	0	0	0	0	0	undefined
RX7	0	0	0	0	0	0	0	0	0	undefined
RX8	0	0	0	0	0	0	0	0	0	undefined

Receiver:

Can receive from a CobraNet transmitter on the network one bundle made up of up to 8 audio channels.

Bundle:

The basic CobraNet audio routing component; assign a specific Bundle number here. A Receiver can carry 0 (channel will not be mapped to mixer) to 8 audio channels.

1-8 Audio Channels:

The number of audio channels in the bundle to be routed to the particular Receiver; channels 0 (inactive) and 33-64 can be assigned.

Status:

Displays 'Receiving' when a bundle is successfully routed to it.

Dropouts:

Displays number of times bundle reception has been interrupted. Interruptions can be caused by transmitter failure or by reconfiguring the receiver.

15.5.2.1.4 User Control Buttons
Refresh:

Updates fields and statuses. If clicked before Apply, clears any changes made.

Apply:

Accepts changes and leaves dialog box open.

OK:

Accepts changes and closes dialog box.

Cancel:

Does not accept any changes made and closes dialog box.

15.5.2.2 How To Configure and Transmit a Bundle

The minimum configuring needed to test basic functionality of sending and receiving a bundle is to set a transmitter bundle and channels on one CobraNet device, and then set the receiver of another CobraNet device to the same bundle number, plus assign its channel numbers.

For example, an ASI6416 is installed in a computer, ASIControl is opened and is used to play a stereo audio file in the ASI6416's Player 1. The Repeat box is checked to have continuous audio playing.

ASIControl is then used to set the ASI6416's first transmitter to have bundle number and channel assignments. Double clicking in receiver 1's bundle field makes it editable and 255 (for example) is typed in. Double clicking in the receiver 1, channel 1 box makes it editable and 1 is typed in (numbers 0 and 1-32 can be used). Hitting the Tab key auto fills the rest of the channels. Since only two channels are needed, double clicking in the channel 3 box, typing in 0, and then hitting the Tab key changes channels 3-8 to have 0s in them. The OK button is clicked and the dialog box closes.

On the same CobraNet network is an ASI2416. Its CobraNet Configuration dialog box is opened using ASIControl. Using the same procedures as above, 255 is typed in (since 255 was used in the example above) as the bundle number for the ASI2416's receiver 1, and its first two channels are assigned numbers 33 and 34 (numbers 0 and 33-64 can be used). This time the Apply button is clicked so the dialog box remains open. Immediately in the CobraNet Configuration dialog box the first two channels in receiver 1 turn green and the Status field changes to 'Receiving' to indicate a bundle has been successfully routed to the receiver. If any errors, the receivers would turn red.

Clicking OK closes the CobraNet Configuration dialog box. ASIControl is still open and meter movement is seen in CobraNet_Ch 33 and 34, as well as Line_Outs 1 and 2.

15.5.3 References

http://cirrus.com/en/pubs/appNote/CobraNet_AudioRoutingPrimer.pdf

http://cirrus.com/en/pubs/manual/CobraNet_Programmer_Manual_PM25.pdf

http://www.cirrus.com/en/support/cobranet/design/switched_networks.html

15.6 Network Configuration

15.6.1 Change IP Address

Change the IP address of a CobraNet device here.

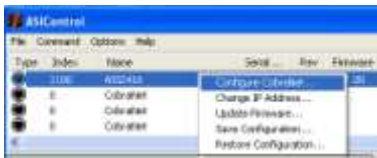

After right clicking on a CobraNet device in ASIControl and selecting “Change IP Address...”, the dialog box below opens.

15.6.1.1 Interface

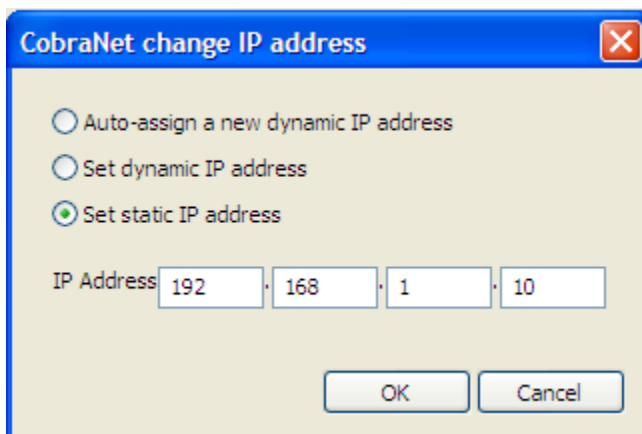

Auto-assign a new dynamic IP address:

The CobraNet device’s current IP address is shown. Double click in the fields to highlight the current number and overwrite it.

Set Dynamic IP address:

You can assign a specific IP address, but it will not survive a power cycle.

Set Static IP address:

You can assign a specific IP address. Providing CobraNet persistence is on, it will survive a power cycle.

15.6.2 Configure Network Interface and Auto-IP Assignment Range

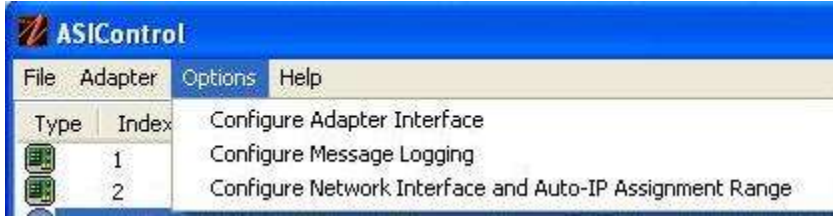

The network interface and the auto-IP assignment range are grouped under Options→Configure Network Interface and Auto-IP Assignment Range. Clicking on it opens the ASIControl – choose network interface dialog box.

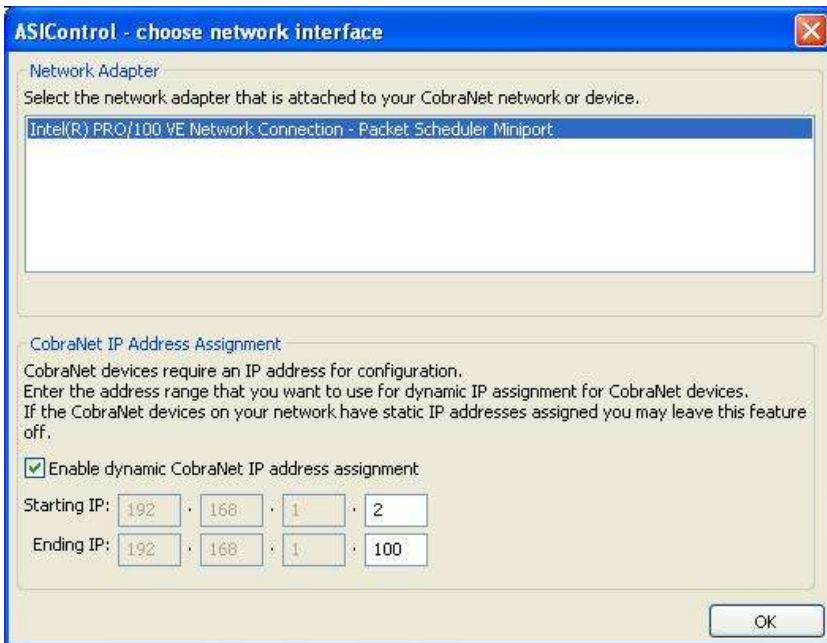

From this dialog box, choose the network adapter to use (if two or more NICs are in the machine).

Check the Enable dynamic CobraNet IP address assignment checkbox, if required. This allows input in the last box of the Starting IP and Ending IP range. Type in the numbers required and click OK.

Figure 16. ASIControl network adapter and IP address assignments

16 APPENDIX 1 CobraNet

16.1 CobraNet™

CobraNet™ is a combination of software, hardware and network protocol that allows distribution of many channels of real-time, high quality, digital audio over an Ethernet network. It was developed by Peak Audio in the 1990s and is now owned by Cirrus Logic. Interoperability between CobraNet devices from different manufacturers is supported through a standard communications protocol. CobraNet compliant devices are based on a common silicon or hardware reference design from Cirrus Logic.

The Cirrus Logic website, www.cobranet.info, is dedicated to CobraNet.

CobraNet delivers audio in standard Ethernet packets over 100Mbit Fast Ethernet. Switches, hubs, media converters, and other gear that operate in compliance with the IEEE 802.3u specification for Fast Ethernet, will work with CobraNet. CobraNet does not support 10Mbit Ethernet varieties (10BASE-T, Coaxial) due to their limited bandwidth.

CobraNet operates at the Data Link Layer (also referred to as OSI Layer 2 or MAC layer). Because it does not use the higher IP layer for audio data transport, CobraNet does not suffer from IP latency limitations. In most cases data communications and CobraNet data can coexist on the same network without QOS issues. All audio is sent inside a custom Ethernet packet whose header tells network devices that the packet contains CobraNet audio, rather than plain data. The CobraNet term for an audio packet is "bundle". A bundle may contain from one to eight audio channels, each channel being composed of PCM samples of 16, 20 or 24 bits in length.

16.2 CobraNet Routing

The whole point of network audio is to route digital audio from point A to point B. CobraNet introduces a concept called a "bundle" to define virtual audio routes from one CobraNet device to another one. A bundle is a logical collection of up to 8 channels that can be sent from one device to another. Each bundle is assigned a unique number between 1 and 65535. Bundles form the heart of the CobraNet routing capability.

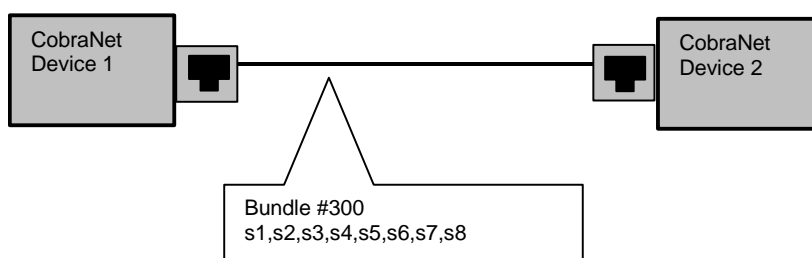

The bundle number 300 is used to describe this collection of channels coming from Device 1. s1 to s8 represent audio samples. The bundle shown above consists of 1 to 8 samples of audio each taken from different channels of Device 1.

Figure 17. Illustration of a CobraNet bundle going between two CobraNet devices

The above figure illustrates a bundle of audio being sent from one CobraNet device to another. Device 1 is transmitting the CobraNet bundle, while Device 2 is receiving it. In this case, both devices need to be set to bundle 300 for the audio link to be made. The CobraNet mechanism for transmitting bundles is "transmitters." Similarly, the mechanism for receiving bundles is "receivers." Each CobraNet device has several transmitters and receivers and so can simultaneously send and receive audio channels using several different bundle numbers. This capability supports audio links between many different CobraNet devices.

16.2.1 Audio Routing Channels

Before further discussion of CobraNet transmitters and receivers, terminology useful for specifying audio channels within a bundle needs to be introduced. Somewhat obviously, these channels are called the Audio Routing Channels. On a Hono Mini CobraNet interface, audio routing channels 1–16 map to input channels 1–16. Similarly, on the output side audio routing channels 33-48 map to output channels 1–16.

Audio Routing Channels

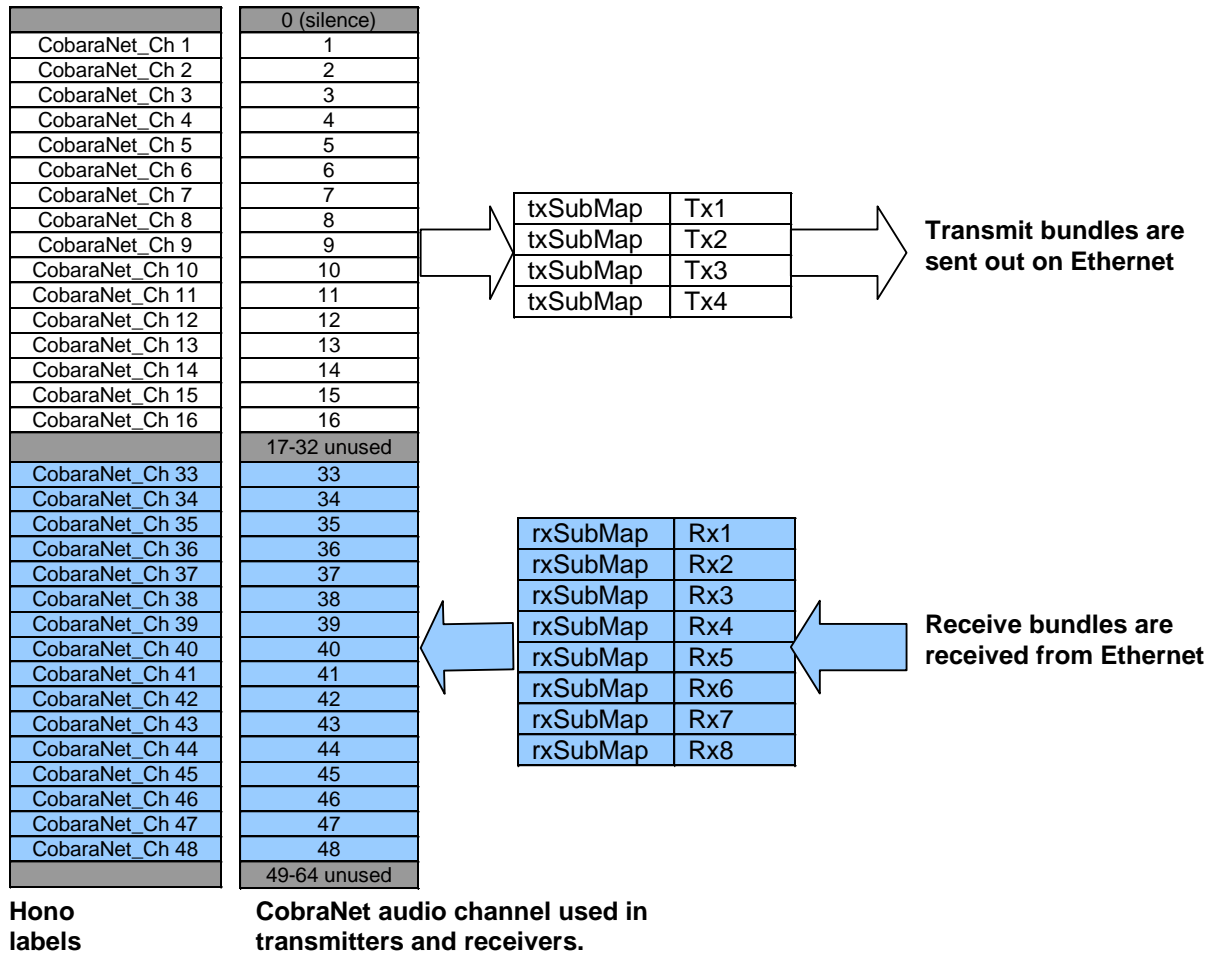

Figure 18. Audio routing channel details.

16.2.2 CobraNet Transmitters

A CobraNet transmitter is a logical entity in the CobraNet interface that has the ability to send a bundle of audio samples on the CobraNet network. CobraNet devices typically have multiple transmitters. Each Hono Mini CobraNet interface, for example, has 4 transmitters. An incomplete list of transmitter routing variables follows:

- txBundle – this variable specifies the bundle number to transmit. A value of 0 indicates that the transmitter is disabled.
- txSubMap – a sequence of up to 8 audio routing channel numbers that specify which audio samples should be placed in the bundle. A value of 0 indicates an unused slot in the bundle.
- txSubFormat – a sequence of format specifiers that define how many bits per sample are placed in the bundle.
- txSubCount – the number of channels in this bundle.

16.2.3 CobraNet Receivers

A CobraNet receiver is a logical entity in the CobraNet interface that has the ability to receive a bundle of audio samples from the CobraNet network. CobraNet devices typically have multiple receivers. Each Hono Mini CobraNet interface, for example, has 4 receivers. An incomplete list of receiver routing variables follows:

- rxBundle – the number of the bundle to receive. This should be the same bundle number being transmitted somewhere else on the network. A value of 0 indicates that the receiver is disabled.
- rxSubMap – a sequence of up to 8 audio routing channel numbers that specify where incoming bundle samples should be routed.

16.2.4 CobraNet Sample Rate and Latency

The CobraNet sample rate supported by s fixed at 48kHz with three latency modes of 5.33ms (default), 2.67ms, or 1.33ms.

16.2.5 CobraNet References

This document is not intended to be an expansive guide to CobraNet networking and routing. The Hono Mini CobraNet interfaces adhere to the CobraNet standard through the use of off-the-shelf CobraNet silicon from Cirrus Logic. More detailed CobraNet information is available from Cirrus Logic's website.

The following links may be helpful:

CobraNet Info:

<http://www.cobranet.info/en/support/cobranet/>

CobraNet CobraCAD and CobraNet Discovery:

<http://www.cobranet.info/dispatch/forms/sup/boardreg/breg/BregController.jpg>

CobraNet Audio Routing Primer:

http://cirrus.com/en/pubs/appNote/CobraNet_AudioRoutingPrimer.pdf

Hardware Manual and Programmer's Reference:

http://www.cobranet.info/en/support/cobranet/developer/tech_data_sheet.html

Switched Networks and Redundancy:

http://www.cirrus.com/en/support/cobranet/design/switched_networks.html

<end>