

### 1 DESCRIPTION

The ASI1451 is a GPIO module intended for use in the ASI2416 Modular CobraNet™ Interface. It contains 16 opto-isolated inputs and 16 relay isolated outputs.

Up to four ASI1451 modules may be used in one ASI2416, allowing up to 64 opto-isolated inputs and 64 relay outputs in a 1RU interface.

The ASI1451 uses a Terminal Block connector, the ASI1493.

### 2 FEATURES

- Sixteen opto-isolated inputs
- Sixteen relay isolated outputs
- Terminal Block connector
- Up to four modules can be used in one ASI2416

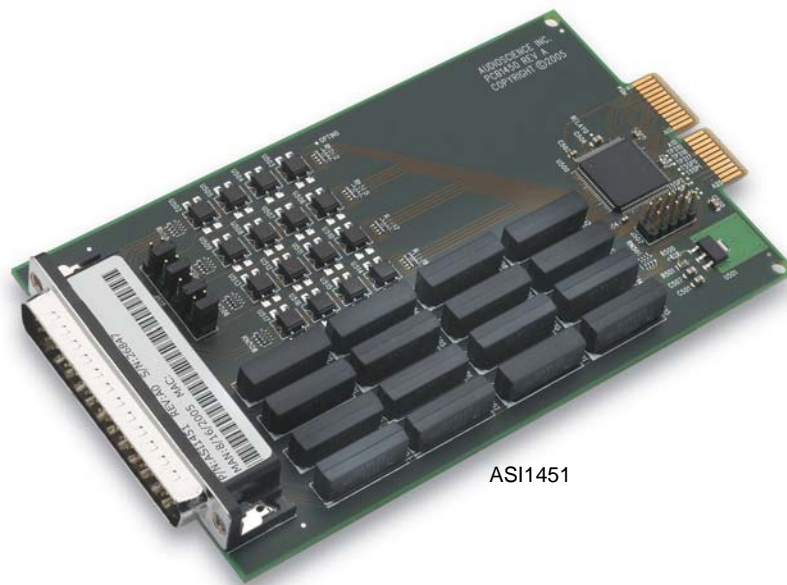

ASI1451

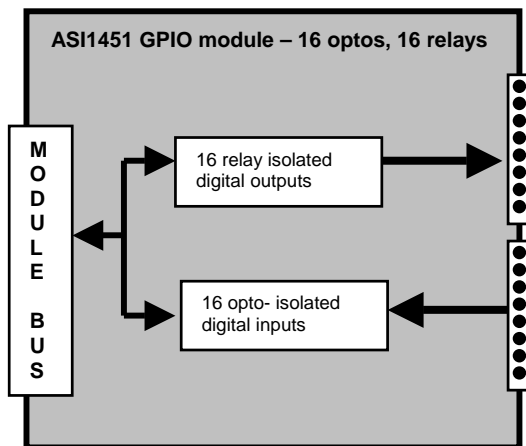

ASI1493  
Phoenix

### 3 SPECIFICATIONS

#### OPTO-ISOLATED INPUTS

Isolation 2000VRMS  
 Input Drive 4mA typical with internal 5V supply and internal 1K current limiting resistor

#### RELAY OUTPUTS

Isolation 1500VRMS between relay contacts and coil  
 Contact Rating Up to 200VDC and 500mA, 10W maximum

#### CONNECTOR MODULES

ASI1493 5 position 3.81mm pluggable terminal block (8 per module)

#### GENERAL

Bus AudioScience ASI2400 series module bus  
 Dimensions (Without Module Connector) 5.5" x 3.25" x 0.6" (140mm x 83mm x 15mm)  
 Weight 8 oz (227g) max  
 Operating Temperature 0C to 70C  
 Power Requirements +5V @ 250mA



## 4 REVISIONS

Date	Description
27 June 2009	Elaborated first page, second paragraph. Updated format, including adding a REVISIONS section.
07 April 2010	Section 7: Added Rev numbers.

## 5 GP-OUTPUT CONNECTIONS

The GP outputs are organized as four banks (A...D) of four outputs (1...4). Each bank consists of four normally open relays with one side connected to a common. The current through each relay should be limited to 500mA.

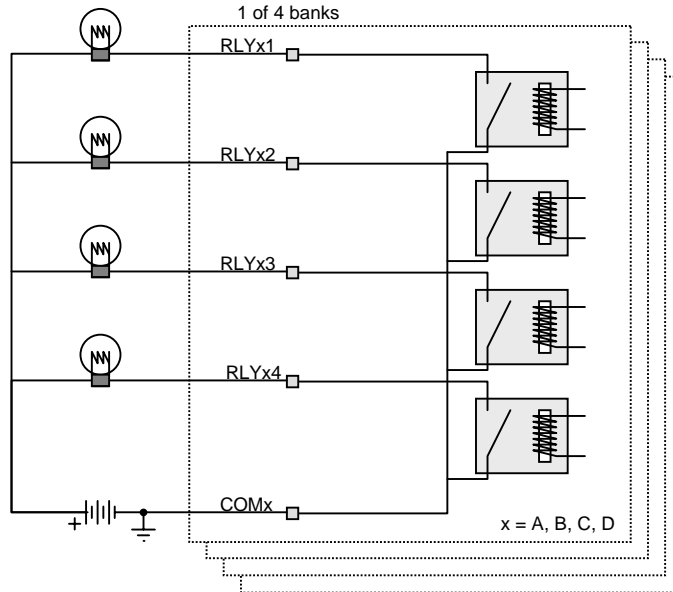

## 6 GP-INPUT CONNECTIONS

The GP inputs are organized as four banks (A...D) of four inputs (1...4). Each bank consists of four opto-isolators.

The voltage powering the LED in the opto-isolator may either be supplied from an external source through the VOPT pin or may be powered from the modules internal +5V supply. The opto-isolator voltage is settable for each bank using jumpers on J512 located on the ASI1451 PCB.

Approximately 5mA is needed to fully turn on each opto-isolator. When using the internal +5V power source then the 1K ohm current limiting resistors are all that is needed. When using an external voltage, the current should be limited to 25mA. With the internal 1K resistor, this means that external voltage of up to +14V can be used.

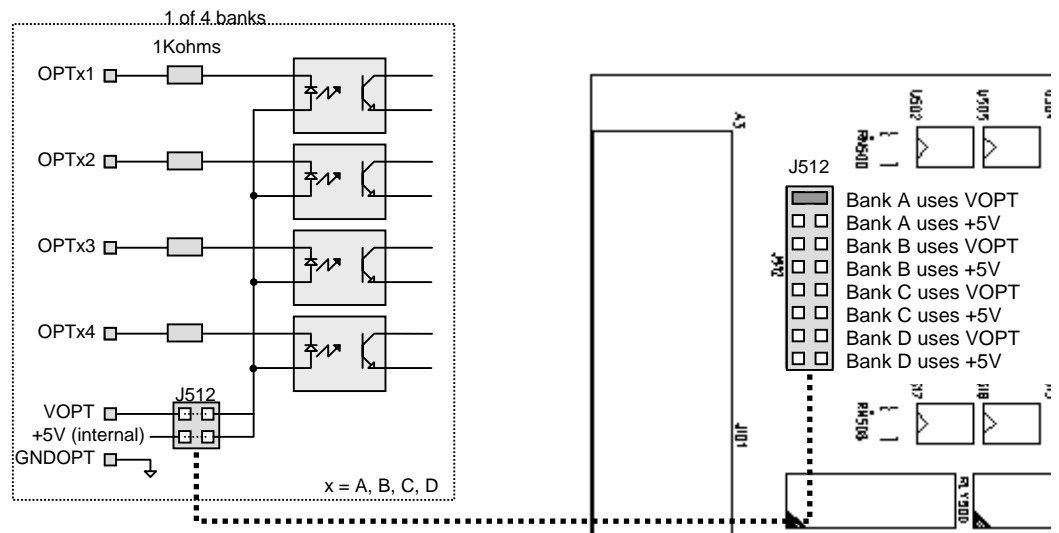

The following diagram shows the connections needed if using the internal +5V to power the opto-isolators.

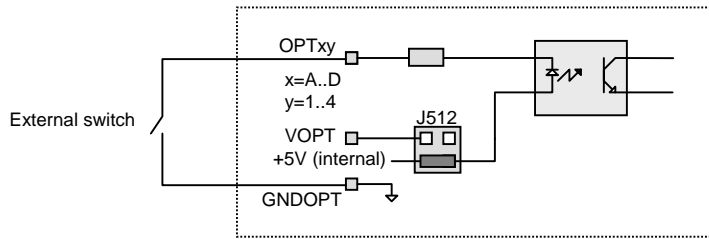

When using an external power source for the opto-isolators, use the following diagram as a guide to connections:

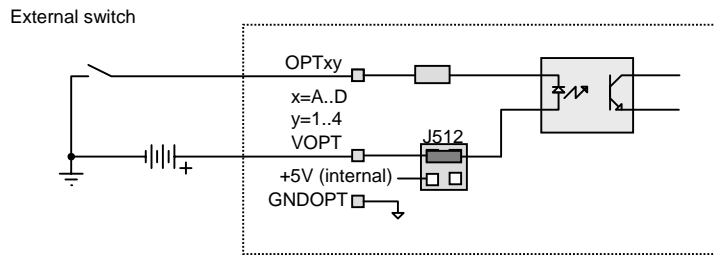

## 7 ASI1493 TERMINAL BLOCK MODULE CONNECTOR

Rev A-E

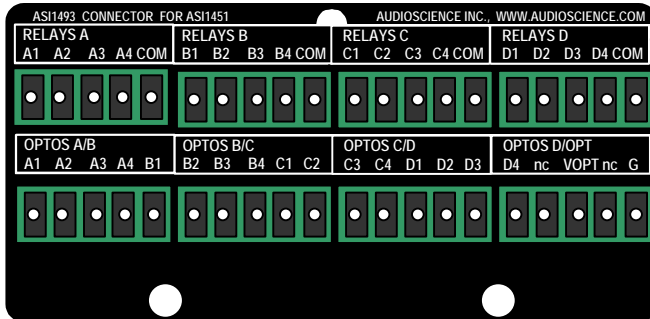

The ASI1493 Terminal Block Module connector provides a 3.81mm Phoenix type connector breakout option for the ASI1451.

ASI1451+ASI1493 combination has the following pinouts:

Terminal Block 1					Terminal Block 2					Terminal Block 3					Terminal Block 4				
1	2	3	4	5	1	2	3	4	5	1	2	3	4	5	1	2	3	4	5
RLY A1	RLY A2	RLY A3	RLY A4	COM A	RLY B1	RLY B2	RLY B3	RLY B4	COM B	RLY C1	RLY C2	RLY C3	RLY C4	COM C	RLY D1	RLY D2	RLY D3	RLY D4	COM D
OPT A1	OPT A2	OPT A3	OPT A4	OPT B1	OPT B2	OPT B3	OPT B4	OPT C1	OPT C2	OPT C3	OPT C4	OPT D1	OPT D2	OPT D3	OPT D4	nc	V OPT	nc	GND OPT
1	2	3	4	5	1	2	3	4	5	1	2	3	4	5	1	2	3	4	5
Terminal Block 5					Terminal Block 6					Terminal Block 7					Terminal Block 8				

<end>