

1 DESCRIPTION

The ASI1443 is an AES/EBU output module intended for use in the ASI2416 Modular CobraNet™ Interface. It has eight channels of output, bundled as four stereo AES/EBU outputs.

Up to four ASI1443 modules may be used in one ASI2416. AudioScience's CobraNet implementation, based on the CobraNet chip used, allows for up to 16 AES/EBU outputs, out of a possible 32, to be used at any given time.

A unique feature of the ASI1443 is its interchangeable I/O connector. A choice of 50pin Centronics (ASI1491), StudioHub+™ (ASI1492), or Terminal Block (ASI1493) allows the module to accommodate a wide variety of interconnection schemes with minimal custom wiring.

2 FEATURES

- Eight channels of output, bundled as four stereo AES/EBU outputs
- 48kHz (CobraNet) operation
- Sample rate converters on all outputs
- Outputs maybe clocked from local 32kHz, 44.1kHz, 48kHz, or 96kHz clock
- Interchangeable Module Connectors with choice of 50pin Centronics connector, StudioHub+™ RJ-45, or Terminal Block schemes with minimal custom wiring.
- Up to four modules can be used in one ASI2416

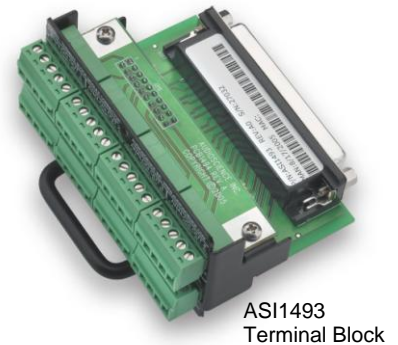
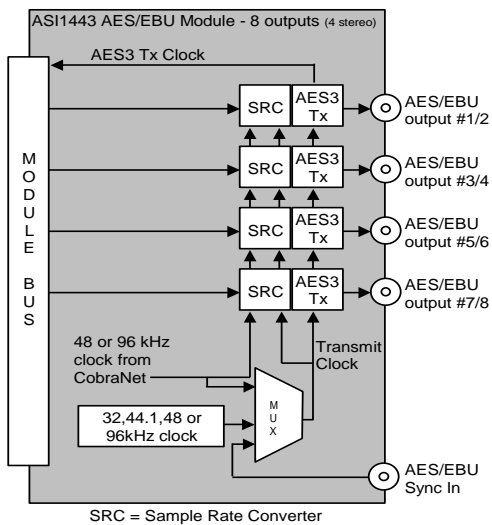

3 SPECIFICATIONS

AES/EBU OUTPUT

Type AES/EBU (EIAJ CP-340 Type I / IEC-958 Professional)
 Sample Rates Internal: 32, 44.1, 48 and 96kHz.

SIGNAL QUALITY

SNR 140dB
 THD+N 135dB

CONNECTOR MODULES

ASI1491 50 pin Centronics
 ASI1492 StudioHub compatible RJ-45 jacks
 ASI1493 5 position 3.81mm pluggable terminal block (8 per module)

GENERAL

Bus AudioScience ASI2400 series module bus
 Dimensions (Without Module Connector) 5.5" x 3.25" x 0.6" (140mm x 83mm x 15mm)
 Weight 8 oz (227g) max
 Operating Temperature 0C to 70C
 Power Requirements +5V @ 500mA



4 REVISIONS

Date	Description
27 June 2009	Elaborated first page, second paragraph. Fixed minor errors on block diagram, first page. Updated format, including adding a REVISIONS section.
05 April 2010	Updated Section 5.3: RevE ASI1493 has a different AES/EBU pinout than revA-D.
06 April 2010	Page 1: Updated block diagram (AES3 Tx Clock, AES/EBU Sync In).

5 MODULE CONNECTORS

5.1 ASI1491 50pin Centronics

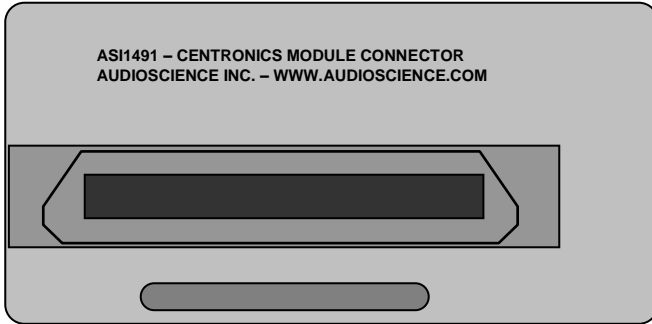

The ASI1491 Module Connector provides a 50pin Centronics connector (also referred to as a 50pin SCSI connector). AudioScience's CBL1146 XLR breakout cable can be used with this connector.

The table on the right shows the pinouts of the connector when used with the ASI1443 AES/EBU Module.

50pin Centronics Connector			
Signal	Pin #	Pin #	Signal
	1	26	
	2	27	
	3	28	
	4	29	
	5	30	
GND	6	31	GND
AES Out 1 -	7	32	AES Out 1 +
AES Out 2 -	8	33	AES Out 2 +
AES Out 3 -	9	34	AES Out 3 +
AES Out 4 -	10	35	AES Out 4 +
	11	36	
	12	37	
	13	38	
	14	39	
	15	40	
	16	41	
	17	42	
	18	43	
	19	44	
	20	45	
	21	46	
	22	47	
	23	48	
	24	49	
GND	25	50	GND

5.1.1 CBL1146- 8 Analog XLR Out Cable



CBL1146, purchased separately, can be used with the ASI1491 50pin Centronics connector and the ASI1443 AES/EBU module. It is a 50pin to 8 out XLR, balanced AES/EBU cable.

5.2 ASI1492 StudioHub+ (RJ45)

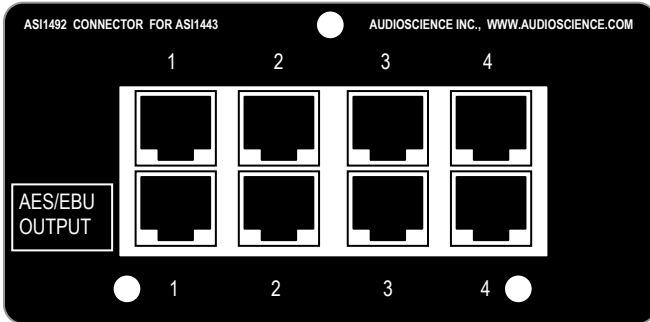

StudioHub (RJ45) Connections		
Pin	Function	Color Code
Shield	Shield	
1	Channel 1/3/5/7 +	White/Orange
2	Channel 1/3/5/7-	Orange/White
3	Channel 2/4/6/8 +	White/Green
4	Ground	Blue/White
5		
6	Channel 2/4/6/8 -	Green/White
7		
8		

The ASI1492 StudioHub Module Connector provides each AES/EBU output on an RJ-45 type jack compatible with the Radio Systems StudioHub standard. This allows the AES/EBU signal to be transmitted using shielded twisted pair (STP) cable. Since AES/EBU audio is stereo, each AES/EBU connection supports a pair of audio channels.

The RJ45 connections are shown in the table to the right. In the diagram on the left, note that only the bottom output jacks are used.

For more information on the StudioHub standard, see www.studiohub.com.

5.3 ASI1493 Terminal Block

The ASI1493 Terminal block Connector provides 3.81mm pluggable terminal blocks.

Each 'Out' in the images below represents a pair of audio channels.

NOTE that the pinouts changed between revD and revE of the ASI1493.

Rev A-D

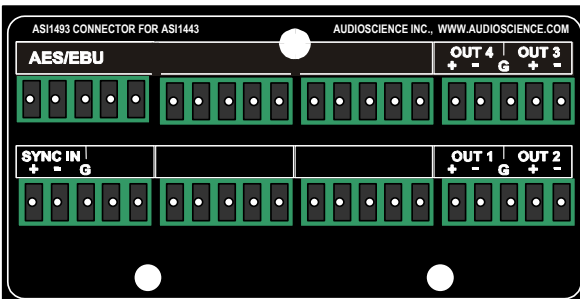

Rev E

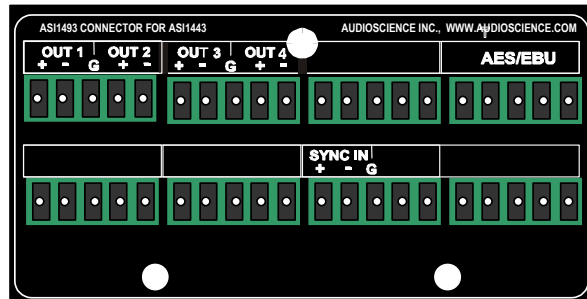

6 MODULE CLOCKING AND SRC

The following diagram shows the sample rate clocking scheme for the ASI1443 module.

ASI1443 AES/EBU Clocking

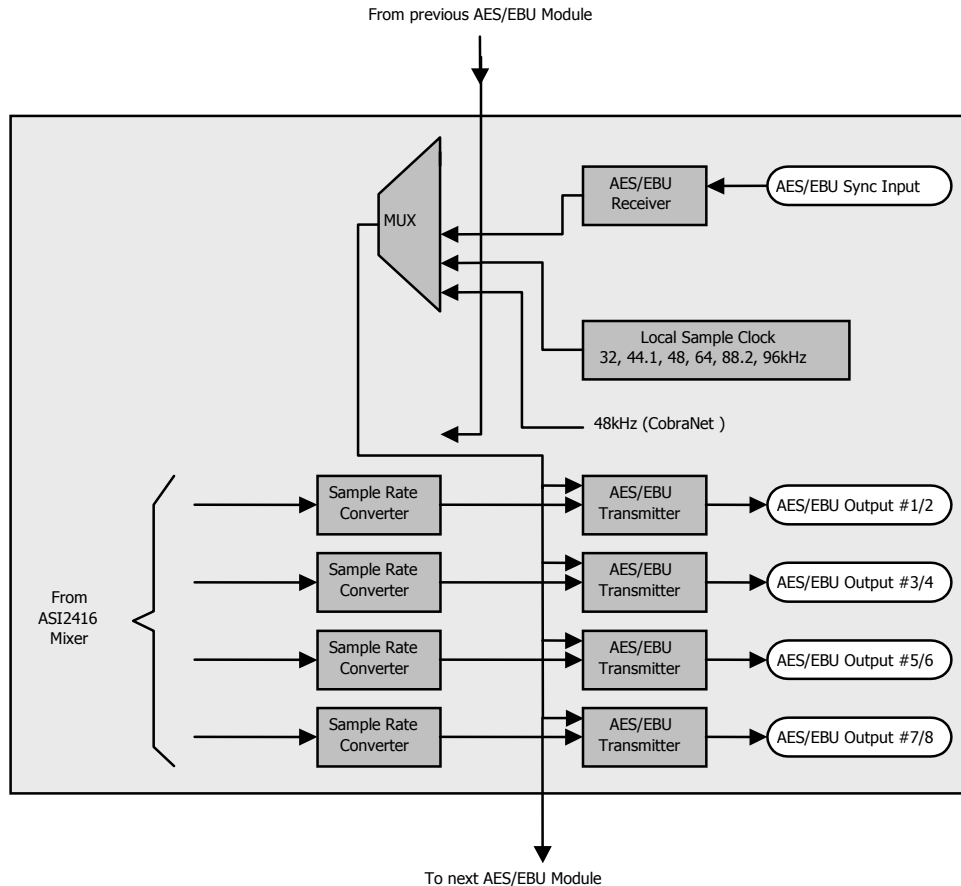

6.1 AES/EBU Outputs

There are the four sample rate sources for clocking the AES/EBU outputs:

1. A sample rate from the ASI1441 module in the previous slot.
2. A local sample rate clock that may be set to 32, 44.1, 48, 64, 88.2 or 96kHz.
3. A sample rate derived from the AES/EBU Sync input (32, 44.1, 48, 64, 88.2 or 96kHz).
4. The ASI2416 CobraNet clock (48kHz).

NOTE: For option #1 to work correctly, multiple ASI1443 modules must be present in the ASI2416 in consecutive slots.

For Example:

Correct: Slot1=ASI1431, Slot2=ASI1443, Slot3=ASI1443

Incorrect: Slot1=ASI1443, Slot2=ASI1431, Slot3=ASI1443

<end>