

# I95

## 1MP Outdoor Speed Dome with D/N, Extreme WDR, SLLS, 30x Zoom Lens





- 1 Megapixel with 720p
- Day & Night with Superior Low Light Sensitivity
- 30x Zoom Lens with f4.3-129mm / F1.6-5.0, DC Iris, Auto Focus
- Extreme WDR (145 dB)
- 30 fps at 1280 x 720
- Endless Pan & Tilt
- Weatherproof (IP67) and Vandal Proof Options (IK10 or IK09)

### PHOTO INDICATION

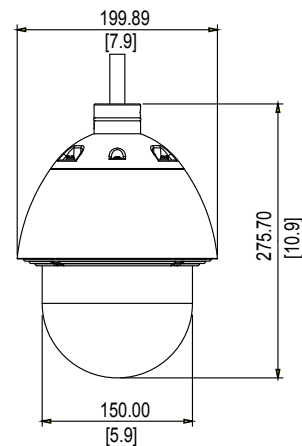



### DIMENSION DIAGRAM



### ACCESSORY OPTIONS

Dome Cover		
PDCX-1005		Transparent, Vandal proof (IK10)
PDCX-1108		Smoked, Vandal proof (IK10)

High PoE Injector		
PPOE-0102		High PoE Injector with universal connector

Popular Mounting Solutions		
Wall	PMAX-0312 PMAX-0702	
Pendant	PMAX-0102	
Corner	PMAX-0312 PMAX-0702 PMAX-0402	
Pole	PMAX-0312 PMAX-0702 PMAX-0503	
Parapet	PMAX-0808	

\* For more mounting solutions, please refer to Project Planner on [www.acti.com](http://www.acti.com)

## PRODUCT SPECIFICATION

### I95

#### • Device

Product Type	Outdoor PTZ Camera
Image Sensor	Progressive Scan CMOS
Sensor Size	1/2.8"
Day / Night	Yes
Superior Low Light Sensitivity	Yes
Minimum Illumination	Color: 0.1 lux at F1.6 (30 IRE, 2400°K); B/W: 0.05 lux at F1.6 (30 IRE, 2400°K)
Color to B/W Switch	ISP based switch, configurable
Mechanical IR Cut Filter	Yes
IR Sensitivity Range	700 - 1100nm
IR LED	No
Electronic Shutter	1/5 - 1/2,000 sec (manual mode); 1/5 - 1/10,000 sec (auto mode)

#### • Lens

Focal Length	Zoom, f4.3 - 129 mm / F1.6 - 5.0
Zoom Ratio	30x optical; 16x digital
Zoom Speed	2.87 sec (1x to 30x)
Iris	DC iris
Focus	Auto focus
Horizontal Viewing Angle	66.4° - 2.61°

#### • PTZ

Manual Panning Speed	0.5° - 90°/s
Manual Tilting Speed	0.5° - 90°/s
Preset Panning Speed	0.5° - 450°/s
Preset Tilting Speed	0.5° - 450°/s
Panning Range	360° Endless
Tilting Range	-20° ~ 200°
Control	Remote manual control; 256 preset points; 10 preset tours; Auto scan
Preset Panning Accuracy	0.265°
Preset Tilting Accuracy	0.265°
Absolute Position	Yes
Protocol	ACTi URL command, Sony VISCA, Pelco D, Pelco P

#### • Video

Compression	H.264, MJPEG
Max. Frame Rate vs. Resolution	30 fps at 1280 x 720; 30 fps at 640 x 480; 15 fps at 320 x 240
Multi-Streaming	Simultaneous dual streams based on two configurations
Bit Rate	28 Kbps - 6 Mbps (per stream)
Bit Rate Mode	Constant, Variable
Image Enhancement	Extreme WDR (145 dB); White balance: automatic, hold and manual; Brightness; Contrast; Sharpness; Automatic gain control; 2D+3D Digital Noise Reduction; Flickerless; Defogging; Digital image stabilizer
Privacy Mask	4 configurable regions
Text Overlay	User defined text on video
Image Orientation	Image flip, mirror and rotation

#### • Audio

Audio	2-way
Compression	8 kHz, Mono, PCM, 16 bit encoding; G.711
Audio-In	Cable without connector
Audio-Out	Cable without connector

#### • Network

Protocol & Service	TCP, UDP, HTTP, HTTPS, DHCP, PPPoE, RTP, RTSP, IPv6, DNS, DDNS, NTP, ICMP, ARP, IGMP, SMTP, FTP, UPnP, SNMP, Bonjour, Sony VISCA, Pelco D, Pelco P
Ethernet Port	1, Ethernet (10/100Base-T), RJ-45 connector
Security	IP address filtering; HTTPS encryption; Password protected user levels; Anonymous login; IEEE 802.1X network access control

#### • Alarm

Alarm Trigger	Video motion detection (3 regions); External device through digital input
Alarm Response	Notify control center; Go to PTZ preset point or preset tour; Change camera settings; Command other devices; E-mail notification with snapshots; Save video or snapshot to local storage; Upload video, Snapshot to FTP server; Activate external device through digital output

#### • Interface

Digital Input	4, cable without connector
Digital Output	2, cable without connector
Local Storage	MicroSDHC/MicroSDXC memory card slot (card not included)

#### • General

Power Source / Consumption	High PoE (IEEE802.3at) / 25.44 W (built-in heater and fan on) AC 24V / 31.5 W (built-in heater and fan on)
Weight	2500 g (5.51 lb)
Dimensions (Φ x H)	200 x 276 mm (7.9" x 10.9")
Environmental Casing	Weatherproof (IP67); Vandal proof casing (IK10); Bundled dome cover (IK09), Optional dome cover (IK10)
Mount Type	Pendant, Wall, Corner, Pole, Parapet
Starting Temperature	-40°C ~ 50°C (-40°F ~ 122°F) within 30mins
Operating Temperature	-40°C ~ 50°C (-40°F ~ 122°F)
Operating Humidity	10% ~ 85% RH
Approvals	CE (EN 55022 Class B, EN 55024), FCC (Part15 Subpart B Class B), IP67, IK09, NEMA 4X

#### • Integration

Unified Solution	Fully compatible with ACTi software
ISV Integration	Software Development Kit (SDK) available; ONVIF Compliant
Firmware Access Browser	Microsoft Internet Explorer 8.0 or newer (full functionality) Safari with QuickTime installed, and other browsers with VLC installed (partial functionality)

\* All specifications are subject to change without notice.

\* All brand names and registered trademarks are the property of their respective owners.

[www.acti.com](http://www.acti.com)

